

The information and specifications included in this publication were in effect at the time of approval for printing. Honda Motor Co., Ltd., reserves the right, however, to discontinue or change specifications or design at any time without notice and without incurring any obligation.

Accessories Precautions

The GPS antenna is located in the dashboard. Metallic front or side window tinting can seriously degrade or obstruct GPS reception.

Signal noise from devices such as radar detectors, vehicle tracking devices, remote starters, and additional amplifiers can disrupt the navigation system. If you install any such item, install it away from the navigation display and antenna.

Important Safety Information

WARNING

Using the navigation system while driving can take your attention away from the road, causing a crash in which you could be seriously injured or killed.

Only operate system controls when the conditions permit you to safely do so.

Avoid focusing on the screen or manually operating the system controls while driving.

Enter information before you begin driving or when stopped. As you drive, listen to the audible instructions and use voice commands when possible. Pull to the side of the road if you need more time to look at the screen or operate the controls.

Route guidance may conflict with street closures, road construction, detours, and out-of-date map data.

The system itself may also have limitations. Verify route information by carefully observing roads, signs, and signals. Always use your own judgment and obey traffic laws.

 **System Limitations** P. 302

NOTICE

This vehicle's navigation display, if so equipped, includes mercury-containing components. Upon removal, please reuse, recycle, or dispose of as hazardous waste. Clean the screen with a soft, damp cloth. You may use a mild cleaner intended for use on navigation screens.

Contents

➤ System Setup P. 19

Start-up 20	Voice Control System 22	Interface Settings 26	Personal Information 38
Routing 53	Guidance 62	Map 69	Data Reset 87
On Demand Multi-Use Display™ 88			

➤ Navigation P. 89

Entering a Destination 90	Calculating the Route 115	Driving to Your Destination 118	Map Menu 125
Changing Your Route 133	Changing Your Destination 142	Resuming Your Trip 145	

➤ Audio P. 147

Audio System 148	Audio Remote Controls 153	Audio Settings 155	Playing FM/AM Radio 158
Playing SiriusXM® Radio 164	Playing a Disc 171	Playing Hard Disc Drive (HDD) Audio 178	
Playing an iPod 190	Playing Internet Radio 202	Playing a USB Flash Drive 207	Playing <i>Bluetooth</i> ® Audio 213

➤ *Bluetooth*® HandsFreeLink® P. 217

<i>Bluetooth</i> ® HandsFreeLink® 218	Text/E-mail Message 252	Roadside Assistance 260	HFL Menus 261
---------------------------------------	-------------------------	-------------------------	---------------

➤ AcuraLink® Messages P. 265

AcuraLink® 266

➤ Other Features P. 277

Trip Computer 278	Calendar 279	Information Functions 280
-------------------	--------------	---------------------------

➤ Troubleshooting P. 283

Troubleshooting 284	Error Messages 290
---------------------	--------------------

➤ Reference Information P. 299

System Initialization 300	System Limitations 302	Client Assistance 304	Legal Information 307
---------------------------	------------------------	-----------------------	-----------------------

➤ Voice Commands P. 313

Voice Commands 314	List of Categories 325
--------------------	------------------------

Quick Reference Guide P. 2

System Setup P. 19

Navigation P. 89

Audio P. 147

Bluetooth® HandsFreeLink® P. 217

AcuraLink® Messages P. 265

Other Features P. 277

Troubleshooting P. 283

Reference Information P. 299

Voice Commands P. 313

Index P. 327

Overview—Functions at a Glance

Navigation

You can select any place/landmark as a destination by using voice control or the Interface Dial. The navigation system gives you turn-by-turn driving directions to your destination.



Store home addresses P. 46

Register **1** home addresses.

Store contacts P. 39

Store up to **200** contacts in **2** address books.

Enter destination P. 90

Select your destination using **13** methods.

Select route P. 117

Set route preferences and select one of **3** routes.



Track route P. 118

Follow your route in real-time with voice guidance.

Subscription service

AcuraLink Real-Time Traffic™ P. 130

Bypass congestion and traffic incidents.

Avoid certain areas P. 60

Set streets and areas to detour around.

Add waypoints P. 135

Add up to **4** “pit stops” along your route.



Audio

The advanced audio system provides clear, well-defined sound and makes the most of your music. Enjoy listening to a variety of audio sources, such as:



FM/AM Radio ➔ P. 158

SiriusXM® Radio ➔ P. 164

Compact Disc ➔ P. 171

Hard Disc Drive (HDD) ➔ P. 178

iPod ➔ P. 190

Internet Radio ➔ P. 202

USB Flash Drive ➔ P. 207

Bluetooth® Audio ➔ P. 213



AcuraLink® ➔ P. 266

AcuraLink® provides you with important information and messages between your vehicle and Acura.

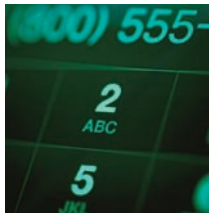

Voice Control ➔ P. 22

Use voice commands for safer system control while driving. You can operate all key functions of the navigation, audio, *Bluetooth*® HandsFreeLink®, and climate control systems.

Bluetooth® HandsFreeLink® ➔ P. 218

Pair a compatible mobile phone to receive incoming and make outgoing calls. You can operate the phone features without ever taking your hands off the wheel.

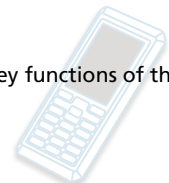

System Controls

On Demand Multi-Use Display™

Navigation Screen

1 PHONE Button ➔ P.218

2 (Power) Button

3 Volume Knob

4 NAV Button

5 BACK Button

6 (Display Mode) Button ➔ P.74

7 Interface Dial/ENTER Button ➔ P.7

8 INFO Button

9 MENU Button

10 SETTINGS Button

Audio Navigation

Voice Control
Bluetooth® HandsFreeLink®

11 (Eject) Button



12 Microphone
➔ P.218

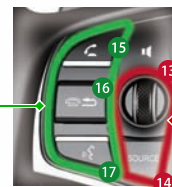

13 Left Selector Wheel ➔ P.153
14 SOURCE Button ➔ P.153

15 (Pick-Up) Button ➔ P.218

16 (Hang-Up/Back) Button
➔ P.218

17 (Talk) Button ➔ P.6

18 AUDIO Button ➔ P.148

On Demand Multi-Use Display™ Basic Operation

Audio Source

Select to change an audio source.



You can change the position of icons.

Shortcuts*1

Places P.44



Phone P.231



Audio P.151



Select **Tune**.



Select **Presets**.



Select and hold a desired number you want to store the station.
Select to listen a preset station.

More

Select to display the menu items.



*1: For detail informations about **Climate**, see your owner's manual.
*2: Pandora® is available on U.S. models only.

FM/AM/SiriusXM®/Pandora®*2/Aha™

- : Select the preset station (FM/AM/Pandora®*2/Aha™) or category (SiriusXM®). Select and hold to search that station on preset screen. (AM/FM/SiriusXM®)
- : Select to search the selected band for a station with a strong signal. (AM/FM) Select the channel. In channel mode, select and hold to change the channel rapidly. (SiriusXM®) Select a song (Pandora®*2) or a contents (Aha™).

CD/HDD/USB flash drive/Bluetooth® Audio

- : Select to skip to the next folder, and to skip to the beginning of the previous folder.
- : Select to change tracks. Select and hold to move rapidly within a track.



iPod

Album bar: Select an album.

- : Select to change tracks. Select and hold to move rapidly within a track.

Voice Control Operation



Voice Portal Screen

- 1 Press and release the  (Talk) button on the top screen of any mode. The system prompts you to say a voice command and gives examples. Press and release the  (Talk) button again to bypass this prompt.





- The system beeps when ready for a command. Press the  (Hang-Up/Back) button to cancel.
- Available voice commands are highlighted on the screen.

- 2 Say a voice command (e.g.,  Address). After that, follow the voice prompt and say a voice command.

- The audio system is muted during voice control mode.
- You can use other voice commands on the Voice Portal screen.
Voice Commands ➔ P. 314
- Say  "Voice Help" to enter supported commands for the current screen. A voice help tutorial is also available.
Voice Help ➔ P. 15
- During the voice control mode, press and hold the  (Hang-Up/Back) button to return to the Voice Portal screen.
- Set **Voice Prompt to Off** to bypass the voice prompt.
Voice Recognition Settings ➔ P. 24
- Carefully read the usage note for the voice control.
Voice Control System ➔ P. 22



On the Menu Screen

- 1 Press and release the  (Talk) button on the menu or setting screen. The system prompts you to say a voice command and gives examples. Press and release the  (Talk) button again to bypass this prompt.



Available voice commands are highlighted on the screen.

- 2 Say a voice command.

- Say  "Voice portal" to display the Voice Portal on any screen.
- Say  "Voice Help" to enter supported commands for the current screen. A voice help tutorial is also available.
Voice Help ➔ P. 15

Interface Dial/ENTER Button Operation

Rotate dial 

Changes scale
Map screens







Highlights menu options
Menu screens

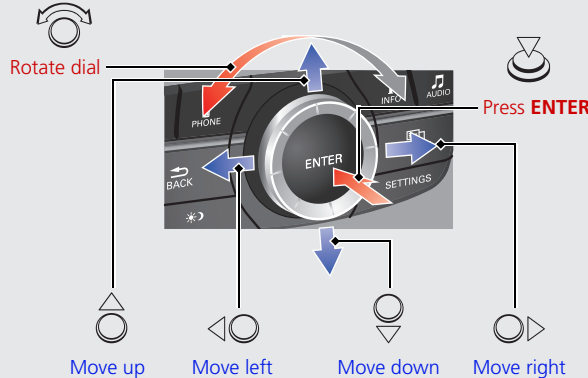

You will see these icons in each chapter.
They represent how you can operate the Interface Dial.



Move

 up  down  left  right

Scrolls map (8 directions)
Map screens

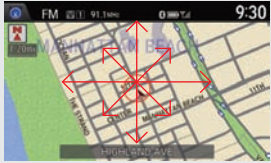

Selects labeled function
Menu screens



Press ENTER 

Selects function
Selects map icon
Map screens

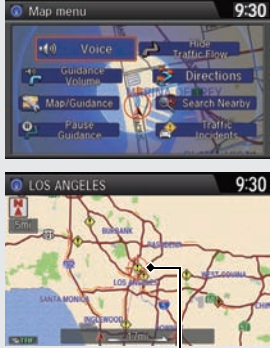

Selects highlighted option
Menu screens





How to Enter Information

You can enter information (e.g., city names, street names, personal names, and business names comprising letters, numbers, and symbols) when prompted on input screens by two different methods.



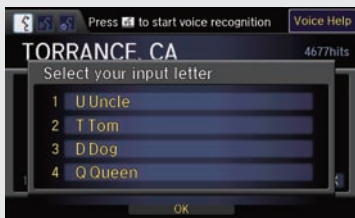

Using Voice Control

When you see  in this manual, voice commands are available for that feature.

- Say the letter, number, or symbol (e.g., say  "A").
- Use spelling assist (e.g., say  "Alpha" to enter the letter "A" or  "Hyphen" to enter a hyphen).
- The system beeps if you say an unavailable (grayed out) letter or number.
- If a voice command is not recognized, a list is displayed with possible options.







On list screens:



- Say the number of the list item (e.g., say  "Five" to select item 5).
- Say  "Up" or  "Previous" to scroll up one page.
- Say  "Down" or  "Next" to scroll down one page.

Using the Interface Dial

Rotate  to highlight a character.

- Select  to display upper/lower case characters.
- Select  to display symbols and accented characters.
- Select  (or move ) to edit the entered characters.

Press  to enter the highlighted character.

- Move  to select **Space** to enter a space character.
- Move  to select **Delete** to remove the last entered character.

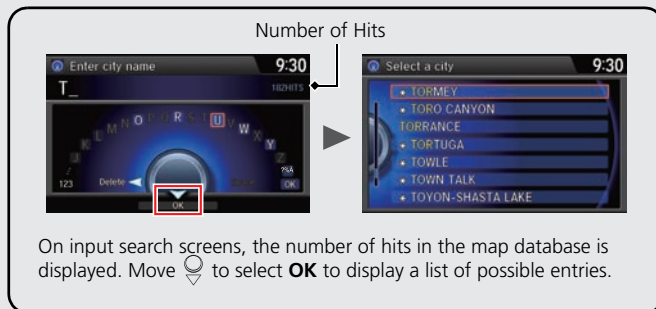

On input search screens, the number of hits in the map database is displayed. Move  to select **OK** to display a list of possible entries.

- You can also use the touch screen to enter information.

Scrolling through lists or tabs is limited while the vehicle is moving. **Certain screen functions are limited or inoperable while the vehicle is moving. For these functions, use available voice commands or pull over to proceed.**

Map Screen Legend

Map orientation → P. 76

- North up
- Heading up
- 3D map

Current map scale

GPS signal strength

- Best reception
- Good reception
- No icon: Poor/No reception

Map scale → P. 81

Feature areas

Park	Airport/Business
Hospital	Water Area
Shopping Mall	Cemetery
Golf Course	University

Streets

- Freeways/highways
- State routes
- Verified streets
- Unverified streets
- One-way streets

Current vehicle position → P. 79

Current street name

AcuraLink® Message icon → P. 14

AcuraLink® signal indicator → P. 275

Landmark icons → P. 71

- Acura dealer
- Honda dealer (U.S.)
- Honda dealer (Canada)
- ATM
- School
- Parking lot
- Parking garage
- Grocery store
- Hotel/Lodging
- Gas station
- Hospital
- Post office
- Restaurant
- Freeway exit information (U.S.) / Highway exit information (Canada)

During Route Guidance

During route guidance, route information is displayed on the map screen and guidance screen. Press the NAV button to toggle between the map and guidance screen.

Map Screen

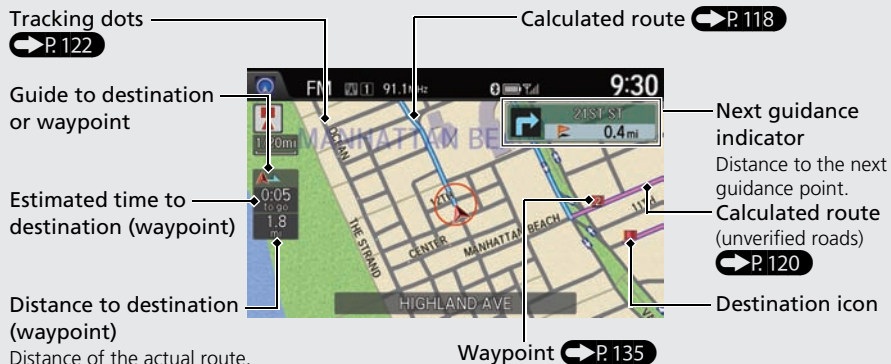

Guidance Screen

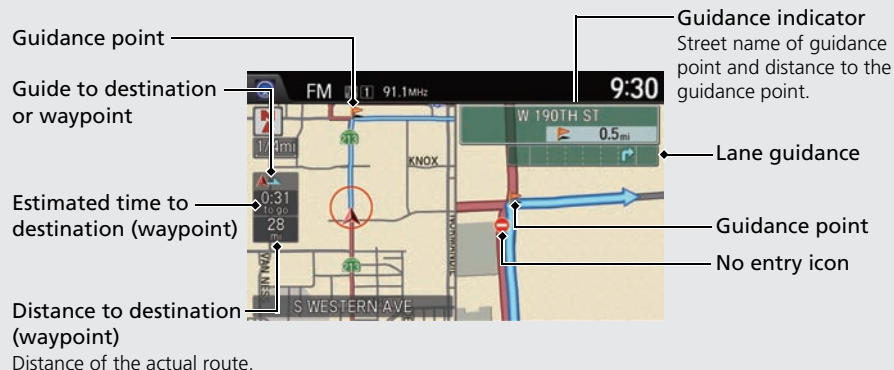

Day or Night Mode

Press the  (Display mode) button to manually switch between day and night mode.

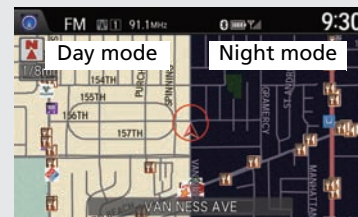

Multi-information Display

Turn-by-Turn Directions

The next guidance appears on the multi-information display.

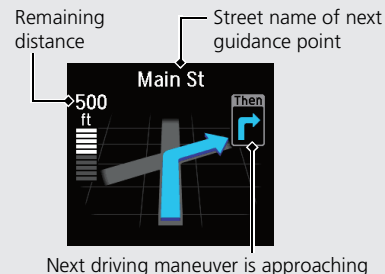



Navigation—Home Addresses and Going Home

The “Home” feature automatically routes you to your home address from any location simply by selecting Go Home, or saying  “Go Home.”



Storing Your Home Address



- 1 Press the **SETTINGS** button.



- 2 Rotate  to select **Navi Settings**. Press .



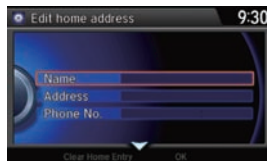

- 3 Rotate  to select **Edit Go Home**. Press .

- 4 Rotate  to select **Name**. Press .





- 5 Enter a name.





- 6 Rotate  to select **Address**. Press .

- 7 Enter an address.

- 8 Rotate  to select **Phone No.** Press .

- 9 Enter a phone number.





- 10 Move  and rotate  to select **OK**. Press .

Going Home

- 1 From the map screen, press the **MENU** button.



- 2 Rotate  to select **Go Home**. Press .



Alternatively, you can say  “Go Home” from any screen. Your home address is displayed on the Calculate Route screen.

- 3 Rotate  to select **Set as Destination**. Press .

- The following voice commands are available: say  “Go Home.”

Navigation—Entering a Destination

Enter your destination using one of several methods, then follow route guidance on the map or guidance screen to your destination. You can also perform these steps using  voice commands.

- 1** From the map screen, press the **MENU** button.



- 2** Rotate  to select **Address**. Press .





- 3** Rotate  to select **Street**. Press .



- 4** Enter the name of your destination street.





- 5** Rotate  to select your destination street from the list. Press .





- 6** Enter the street number. Move  to select **OK** when finished.

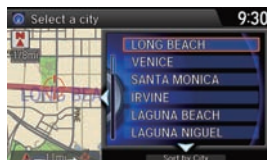

- 7** If there is more than one city with the specified street, a list of cities is displayed. Rotate  to select the desired city from the list. Press .



- 8** Rotate  to select **Set as Destination**. Press . Route guidance to the destination begins.

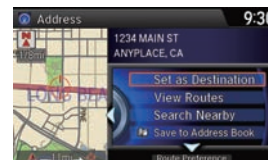

- **View Routes:** Choose one of three routes.



- **Route Preference:** Choose **Max** or **Min** for the five settings.

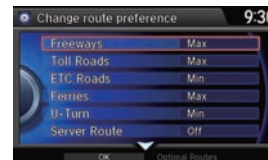









Navigation—Changing Route or Destination

You can alter your route by adding waypoints to visit, adding streets to avoid, or changing your destination during route guidance.



Adding a Waypoint ("Pit Stop")

You can add up to four waypoints along your route. [➔ P. 135](#)

- 1 From the map screen, press the **MENU** button.
- 2 Rotate  to select **Destination List**. Press .
- 3 Rotate  to select **Add New Destination**. Press .
- 4 Rotate  to select **Find Along Route**. Press .
- 5 Rotate  to select location and search method. Press .







- **Search Around:** Search around a location.
- **Search Along:** Search between two locations.

- 6 Select the icon category and location to add to the Destination List when prompted. Edit the order of destinations if necessary.
- 7 Move  and rotate  to select **Start Route**. Press .

Changing Your Destination

There are four methods you can use to specify a new destination during route guidance.

- Say  "**Find Nearest...**" [➔ P. 142](#)
Searches for the nearest place/landmark on the map screen (e.g.,  "**Find nearest gas station**").
- Say  "**Go Home**" [➔ P. 11](#)
Routes to your home address.
- Selecting an icon on the map [➔ P. 143](#)
Scroll the map to position the cursor over a place/landmark icon or a new area on the map. Press  twice.
- Entering a new destination [➔ P. 144](#)
Press the **MENU** button. Move  to select **Destination** and enter a new destination.

Canceling Your Route

- 1 Press the **MENU** button.
- 2 Rotate  to select **Cancel Route**. Press .



AcuraLink®

AcuraLink® Messages

AcuraLink® provides a direct communication link between you and Acura. It sends and receives several kinds of messages through the Acura server.

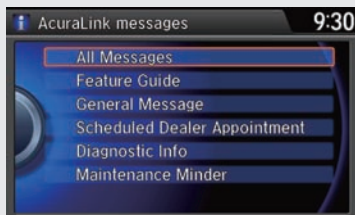

The following features are available:

- Vehicle feature guide
- Operating quick tips
- Safety and maintenance information
- Diagnostic information
- Dealer appointment and maintenance reminders

AcuraLink Real-Time Traffic™

Displays continuously updated traffic information and recalculates your route in response to traffic flow, incidents, or road closures.

➔ P.130

Traffic incident icons

- Congestion
- Incident
- Weather
- Construction
- Road Closed

Traffic status indicator

➔ P.130

- Traffic information available
- Traffic information off or map scale too large
- No icon: Out of coverage area

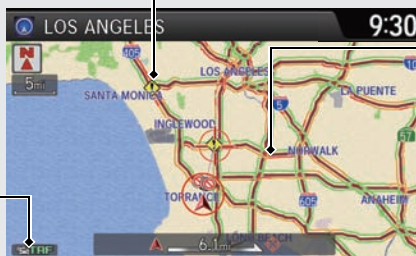

Traffic flow indicator

- Heavy
- Moderate
- Free-flow

NOTE: AcuraLink Real-Time Traffic™ is a subscription service. For more information, contact an Acura dealer or visit owners.acura.com (U.S.) or www.myacura.ca (Canada).

Voice Help

This navigation system comes with voice help, which shows you what command to say when using the voice command functions.

Command Help

- 1 Press and release the  (Talk) button.

- 2 Say  "Voice Help."

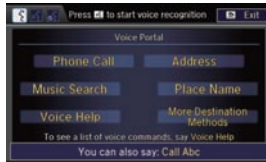



The voice help screen is displayed. The  "Voice Help" command is available on most screens.

- 3 Press and release the  (Talk) button.

- 4 Say one of the options for a list of available commands by category (e.g.,  "Navi commands").



- 5 Press and release the  (Talk) button.



- 6 Say one of the options for a list of available commands by category (e.g.,  "Find Place Commands").

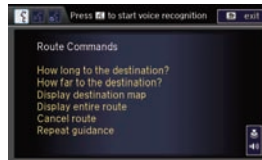

- 7 The system displays a list of all available commands for the category. Press  to hear the list read aloud.



Getting Started Tutorial



- 1 Move  and rotate  to select **Getting Started** on the voice help screen. Press .



For "Voice Settings" and "All Commands."  **P.314**

- 2 Press  to have the system read the tips for the voice control.



- Rotate  to read the tips.
- Move  or  to display the previous/next page.

Q Why does the vehicle position icon on the map “lag” a short distance behind my actual position, especially at intersections?

A This is normal. The navigation system is unaware of the width of intersections. Large differences in vehicle position can indicate a temporary loss of the GPS signal.

Q Why does the “time to destination” display sometimes increase even though I am getting closer to my destination?

A The “time to destination” is based on your actual road speed and traffic conditions to give you a better estimate of arrival time.

Q How do I specify a destination when an entered city or street could not be found?

A Try entering the street first. Some cities are lumped in with a major metro area. In rural “unverified” areas or new subdivisions, streets may be missing or only partially numbered.

Q How do I turn on the navigation system voice guidance?

A On the map screen, press  to display the Map Menu. Rotate  to select **Guidance Volume**. Adjust the preferred volume level.

Q My battery was disconnected or went dead, and the navigation system is asking for a code. Where do I find it?

A In most cases, you do not need to enter a code. Simply press and hold the  (Power) button for two seconds; the system should reactivate.

 **System Initialization** P. 300

How to Use This Manual

This section explains different methods on how you can easily find information in this manual.



Searching the Table of Contents

➔ P.1

Two types of Tables of Contents help you find your desired information.

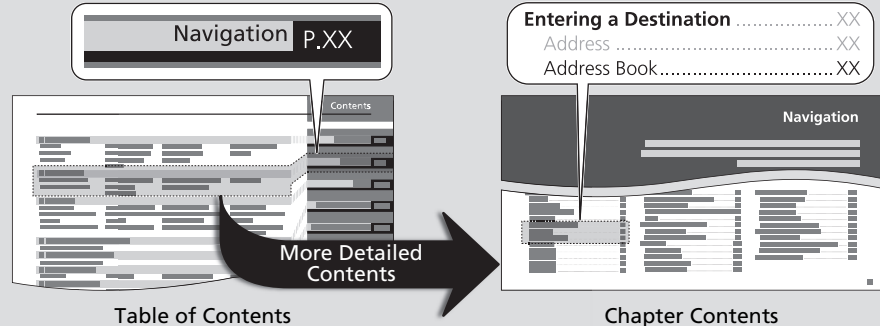

First, find the general chapter related to what you are looking for (e.g., entering a destination from the Address Book). Then, go to that chapter to view a more specific table of contents.

This more detailed table of contents shows you exactly what information is listed by section and title.



Searching the Index ➔ P.327

Menu items displayed on the navigation screen (e.g., Address Book) can be found individually in the Index.

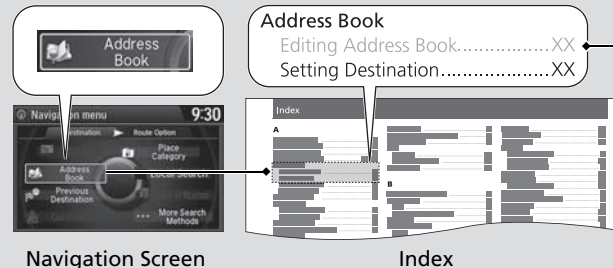

The Index consists of main terms and sub-entries. The sub-entries help you get to the desired page depending on what you are looking for.

Go to the Next page





▶▶ Entering a Destination ▶ Address Book

Address Book

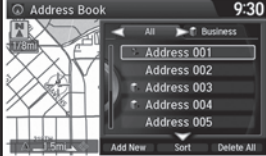
MENU button ▶ Address Book

Select an address stored in your address book to use as the destination.





1. Rotate  to select your destination from the list. Press .
2. Set the route to your destination.
 - ▶ **Calculating the Route P. 92**
 - ▶ Move  or  to display only the entries in the categories you have created.
 - ▶ **Selecting an Address Book Category P. 26**

Address Book

If you have PIN-protected your address book, enter your PIN when prompted. Press  to select OK. PINs are optional.

▶ **PIN Numbers P. 28**

Move  and rotate  to select the following items:

- ▶ **Add New Address.** Adds an entry to the address book.
 - ▶ **Adding an Address Book Entry P. 23**
- ▶ **Sort:** Selects Sort by Name or Sort by Distance.
- ▶ **Delete All:** Deletes all entries in the address book.

After following the menu tree, step-by-step instructions explain how to achieve the desired result.



Menu Tree

The menu tree helps guide you through the system's menu options. To get to your desired function, follow the menu tree in order of the steps shown.

All menu options can also be activated with voice commands.

MENU button ▶ Address Book

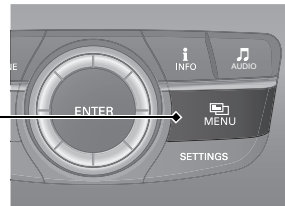



Press the hard button on the system control panel.

Press the **MENU** button.



Select the menu option with the Interface Dial.

Rotate  to select **Address Book**. Press .

Sample pages and images in this section may differ from the actual ones.

System Setup

This section describes the start-up procedure and the navigation and setup functions.



Start-up	20	Unverified Routing	56	3D Angle Adjustment.....	77
Voice Control System	22	Traffic Rerouting	58	Straight Line Guide	78
Command Input	22	Edit POI Search Radius Along Route	59	Current Location	79
Voice Recognition	23	Avoided Area	60	Map Legend.....	80
Interface Settings	26	Guidance	62	Display Tracking.....	84
Personal Information	38	Guidance Mode	63	Correct Vehicle Position	86
Address Book.....	39	Street Name Guidance	65	Data Reset	87
Home Address	46	Non-map screens	66	Defaulting All the Settings.....	87
PIN Numbers	47	Guidance Point	67	On Demand Multi-Use Display™	88
Previous Destination.....	48	Estimated Time	68	Changing the Screen Settings	88
Category History	49	Map	69		
Download POI.....	50	Showing Icons on Map	71		
Routing	53	Color	73		
Route Preference.....	54	View (Map Orientation).....	76		

The navigation system starts automatically when you set the power mode to ACCESSORY or ON. At start-up, the following Confirmation screen is displayed.

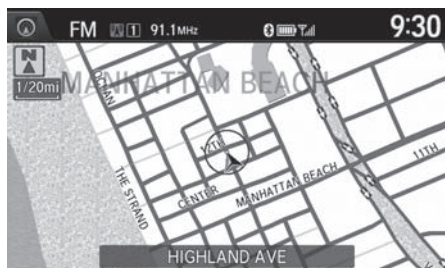
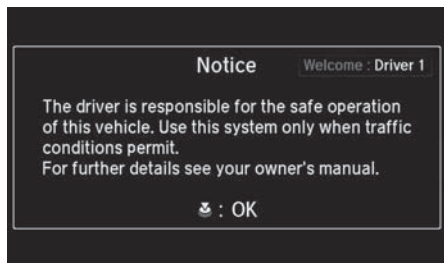

1. Press  to select OK.
 - ▶ If you do not select OK, the map screen is displayed after a certain period of time.
 - ▶ Your current position is displayed on the map screen.

2. Press the NAV button if a different mode is selected.
 - ▶ Your current position is displayed on the map screen.

Start-up

If the navigation system loses power at any time, you may need to press and hold the  (Power) button for more than two seconds, or you may be prompted for the five-digit security code.

System Initialization P. 300

At start-up, the driver's keyless access remote is automatically detected and the address book settings, setup preferences, wallpapers, and audio settings for that driver (e.g., Driver 1) are loaded.

"OK" on the Confirmation screen cannot be selected by using a voice command.

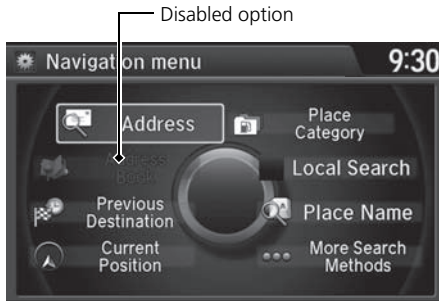

Limitations for Manual Operation



Certain manual functions are disabled or inoperable while the vehicle is in motion. You cannot select a grayed-out option using the Interface Dial until the vehicle is stopped.

Voice commands are still operable while the vehicle is in motion.

Your vehicle has a voice control system that allows hands-free operation of most of the navigation system functions.

The voice control system uses the  (Talk) and  (Hang-Up/Back) buttons on the steering wheel and a microphone near the map lights on the ceiling.

A “Getting Started” feature provides a tutorial that explains how to use the voice control system.

 **Getting Started Tutorial** P. 15

Command Input

If the system does not understand a command or you wait too long to give a command, the system asks you to repeat the command.

When you give a command, the system generally either repeats the command as a confirmation or asks you for further information. If you do not wish to hear this feedback, you can turn it off. However, listening to the feedback will help familiarize you with the way the system expects commands to be phrased.



If the system cannot perform a command or the command is not appropriate for the screen you are on, the system beeps.

On character input screens, a list of possible characters is displayed if the system does not recognize your command.

You can find out which voice commands are available for a particular screen using the  “Voice Help” command. The system will display and read the list of available commands to you.

 **Voice Help** P. 15

Voice Control System

When you press the  (Talk) button, the system prompts you to say a voice command and gives examples. Press and release the  (Talk) button again to bypass this prompt and give a command.

Command Input

The audio system is muted while using the voice control system.

Voice Recognition

To achieve optimum voice recognition when using the navigation voice control system:

- Make sure the correct screen is displayed for the voice command that you are using.
 - **Voice Commands** P. 314
- Close the windows and moonroof.
- Adjust the dashboard and side vents so air does not blow onto the microphone on the ceiling.
- Speak clearly in a clear, natural speaking voice without pausing between words.
- Reduce any background noise and the climate controls fan speed if possible. The system may misinterpret your command if more than one person is speaking at the same time.
- Refer to the Voice Help feature.
 - **Voice Help** P. 15



☒ Voice Recognition

The voice control system can only be used from the driver's seat because the microphone unit removes noises from the front passenger's side.

Voice Recognition Settings

🔗 **SETTINGS** button ▶ **System Settings** ▶ **Voice Reco**



Rotate  to select an item. Press .

The following items are available:



- **Guidance Volume:** Adjusts the voice prompt volume level.
 - ▶ **Sound and Beep Settings** P. 27
- **Voice Prompt:** Turns the voice prompt on or off.
 - On** (factory default): Provides the voice prompts.
 - Off:** Disable the feature.
- **Song By Voice:** Turns the Song By Voice™ on or off.
 - ▶ **Settings Song By Voice™ (SBV)** P. 197
- **Song By Voice Phonetic Modification:** Modifies a voice command of music stored in the HDD or an iPod.
 - ▶ **Phonetic Modification** P. 199
- **Phonebook Phonetic Modification:** Modifies a voice command for the phonebook.
 - ▶ **Phonebook Phonetic Modification** P. 234

Siri Eyes Free

When your iPhone is paired and linked to the system via *Bluetooth*®, you can say Siri-related commands. Make sure Siri on your iPhone is turned on.

📱 **Pairing a Phone** P. 221



1. Press and hold the  (Talk) button for more than two seconds until you hear the Siri tone.
2. Talk to Siri.
 - ▶ When you hear the Siri tone, you can continue to respond without pressing any button. If the Siri tone times out, you have to press and hold the  (Talk) button again to reactivate Siri Eyes Free.
 - ▶ Press the  (Hang-Up/Back) button to turn off Siri Eyes Free.

📱 Siri Eyes Free

iPhone and Siri are trademarks of Apple, Inc.

Siri Eyes Free is available only on iPhone with iOS 6.0 and above.

Some commands work only on specific phone features or apps.

Some features may not be available for all countries or all areas. For details about Siri, refer to <http://www.apple.com>.

We recommend against using Siri other than in Eyes Free mode while operating a vehicle.

On Siri Eyes Free, the display remains the same and no feedback or commands appear.





While using Siri, you cannot operate the system with the built-in voice recognition.

Display Settings

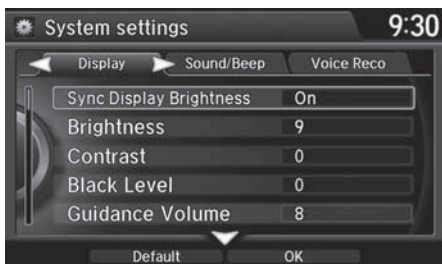
🔗 **SETTINGS** button ▶ **System Settings** ▶ **Display**

Adjusts the screen's preferences.



1. Rotate  to select an item. Press .
2. Rotate  to make the adjustment. Press .

The following items are available:

- **Sync Display Brightness:** Selects whether the display brightness synchronizes with the instrument panel brightness.
- **Brightness:** Adjusts the screen's brightness.
- **Contrast:** Adjusts the screen's contrast.
- **Black Level:** Adjusts the screen's black level.

Display Settings



You can set separate daytime and nighttime settings for **Brightness**, **Contrast**, and **Black Level**. Adjust each setting when the display is in either daytime or nighttime mode.

Sound and Beep Settings

 **SETTINGS** button ▶ **System Settings** ▶ **Sound/Beep**

Changes the system sound and beep settings.



Rotate  to select an item. Press .

The following items are available:

- **Guidance Volume:** Adjusts the navigation system volume level.
- **Interface Dial Feedback:** Sets if and when the system reads aloud a selection made using the Interface Dial.
On: Always reads the selection.
Off: Disables the feature.
Auto (factory default): Reads the selection only when the vehicle is moving.
- **Message Auto Reading:** Selects whether the system automatically reads out messages, and, if selected, whether only when driving.
On: Always reads the message.
Off: Disables the feature.
Auto (factory default): Reads the message only when the vehicle is moving.
- **Verbal Reminder:** Turns the verbal reminders on and off.
On: Sets the verbal reminders.
Off: Disables the feature.

Sound and Beep Settings

Guidance Volume

If you set **Guidance Volume** to 0, you will not hear route guidance or voice command confirmations. You can also adjust **Guidance Volume** by rotating the volume knob while the route guidance or voice command confirmations is announced.

If you then select **Voice** in the Map Menu, you will hear route guidance at the default volume.

Interface Dial Feedback



You can use this feature to minimize the need to look at the screen while operating the Interface Dial.

Clock Adjustment

🔍 **SETTINGS** button ▶ **System Settings** ▶ **Clock**

Set the automatic adjustment of the system clock for daylight saving and international time zones.



Rotate  to select an item. Press .

The following items are available:

- **Clock/Wallpaper Type:** Changes the clock display type and the wallpaper type.
 - ▶ **Setting the Clock Type** P. 29
- **Clock Adjustment:** Adjust the current time manually.
 - ▶ **Setting the Clock** P. 29
- **Clock Format:** Sets the time notation to either 12-hour clock (**12H**, factory default) or 24-hour clock (**24H**).
- **Auto Time Zone:** The navigation system automatically adjusts the clock when driving through different time zones.
 - On** (factory default): Adjusts the clock automatically.
 - Off:** Disables the feature.
- **Auto Daylight:** The navigation system automatically adjusts the clock ("spring ahead" or "fall back" by one hour) when a daylight saving time change occurs.
 - On** (factory default): Adjusts the clock automatically.
 - Off:** Disables the feature.
- **Clock Reset:** Resets the settings of all items in the **Clock** group.

🔍 Clock Adjustment

Auto Time Zone

If you live and work in two different time zones, you may want to turn **Auto Time Zone** to **OFF**. When driving near a time zone boundary, the displayed time zone may fluctuate between the two zone times.

Auto Daylight

This function is not activated in areas that have not adopted daylight saving time, even if you have set **Auto Daylight** to **ON**.

You can turn the clock display in the navigation screen on and off.

▶ **Header Clock Display** P. 37

Setting the Clock Type

SETTINGS button ▶ System Settings ▶ Clock ▶ Clock/Wallpaper Type
▶ Clock



1. Rotate to select an option to change the design. Press .
2. Move to select OK. Press .

Setting the Clock

SETTINGS button ▶ System Settings ▶ Clock ▶ Clock Adjustment

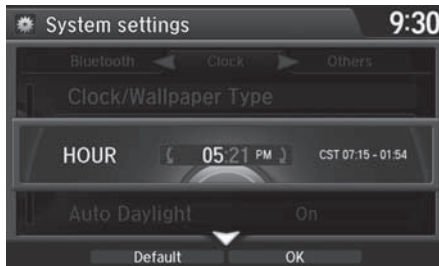

1. Rotate to select an item. Press .
2. Rotate to select a minute. Press .

Wallpaper Settings

Select, delete, and import wallpaper pictures for display on the screen.

■ Import wallpaper

🔗 **SETTINGS** button ▶ **System Settings** ▶ **Clock** ▶ **Clock/Wallpaper Type**



1. Connect the USB flash drive to the USB port.
2. Move to select **Wallpaper**.
▶ The screen will change to the wallpaper list.
3. Move and rotate to select **Add New Wallpaper**. Press .
4. Rotate to select a desired picture. Press .
▶ The preview is displayed on the left side on the screen.
5. Move and rotate to select **Start Import**. Press .
▶ The confirmation message will appear. Then the display will return to the wallpaper list.

🔗 Wallpaper Settings

- When importing wallpaper files, the image must be in the USB flash drive's root directory. Images in a folder cannot be imported.
- The file name must be fewer than 255 characters.
- The file format of the image that can be imported is BMP (bmp) or JPEG (jpg).
- The individual file size limit is 6 MB.
- The maximum image size is 4,800 x 4,800 pixels.
- Up to 10 files can be saved for each driver (Driver1 and Driver2).
- If the USB flash drive does not have any pictures, the No files detected message appears.

Select wallpaper

SETTINGS button ▶ System Settings ▶ Clock ▶ Clock/Wallpaper Type
▶ Wallpaper



1. Rotate to select a desired wallpaper. Press .
 - ▶ The preview is displayed on the left side on the screen.
 - ▶ The pop-up menu appears on the screen.



2. Rotate to select **Set**. Press .
 - ▶ The display will return to the wallpaper list.

Select wallpaper

From the pop-up menu, rotate to select **Preview** and press to see a preview at full-size screen.

To go back to the previous screen, press to select **OK**, or press the **BACK** button.

When the file size is large, it takes a while to be previewed.

Delete wallpaper

📍 **SETTINGS** button ▶ **System Settings** ▶ **Clock** ▶ **Clock/Wallpaper Type**
▶ **Wallpaper**



1. Rotate to select a wallpaper that you want to delete. Press .
 - ▶ The preview is displayed on the left side on the screen.
 - ▶ The pop-up menu appears on the screen.

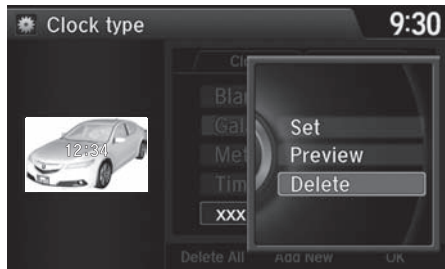



2. Rotate to select **Delete**. Press .
- ▶ The confirmation message will appear.
3. Rotate to select **Yes**. Press .
- ▶ The display will return to the wallpaper list.

Unit Settings

 **SETTINGS** button ▶ **System Settings** ▶ **Others** ▶ **Units**

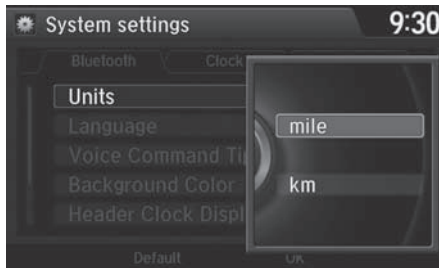
Sets the map units to either mile or km.



Rotate  to select the map unit.
Press .

Language Settings

🔗 **SETTINGS** button ▶ **System Settings** ▶ **Others** ▶ **Language**

Set the system language used on all screens. You can choose from three languages: **English**, **Français** (French), **Español** (Spanish).



Rotate 🔄 to select the system language. Press ⏸.

🔗 Language Settings

Voice confirmation of cities and streets only occurs when **English** is the system language.



When **Français** or **Español** is selected, some messages continue to be displayed in English.

Voice Command Tips

 **SETTINGS** button ▶ **System Settings** ▶ **Others** ▶ **Voice Command Tips**

Alerts you when manual control of the system is disabled to prevent distraction while driving. Only voice commands are available.



Rotate  to select the map unit.
Press .

The following items are available:



- **On** (factory default): Displays a message.
- **Off**: Disables the message.

Background Color

🔑 **SETTINGS** button ▶ **System Settings** ▶ **Others** ▶ **Background Color**

Changes the background color of the navigation screen and the On Demand Multi-Use Display™.





Rotate  to select a desired color.
Press .

Header Clock Display

 **SETTINGS** button ▶ **System Settings** ▶ **Others** ▶ **Header Clock Display**

Selects whether the clock display comes on.



Rotate  to select an option. Press .



The following options are available:

- **On** (factory default): The system displays the clock in the navigation screen.
- **Off**: Disables the feature.

📍 SETTINGS button ► Navi Settings ► Personal Info

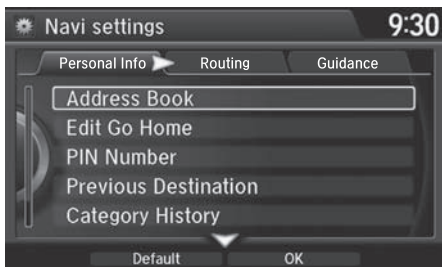
Use the personal information menu to select and set your address books, home address, and PINs. You can also delete unwanted destinations from the list of previously routed destinations.



Rotate  to select an item. Press .

The following items are available:

- **Address Book:** Stores new addresses or edits your address book.
 ➤ **Address Book** P. 39
- **Edit Go Home:** Sets or edits your home address.
 ➤ **Home Address** P. 46
- **PIN Number:** Sets or changes your PIN.
 ➤ **PIN Numbers** P. 47
- **Previous Destination:** Deletes the destination history.
 ➤ **Previous Destination** P. 48
- **Category History:** Deletes the place categories you recently used.
 ➤ **Category History** P. 49
- **Download POI:** Edits and deletes the Imported POI categories.
 ➤ **Download POI** P. 50

📄 Personal Information

Personal information cannot be backed up or moved to another navigation system.

Address Book

 **SETTINGS** button ▶ **Navi Settings** ▶ **Personal Info** ▶ **Address Book**

Store up to 200 address entries in two address books (Driver 1 and Driver 2). You can add, edit, and delete information in the address books.



Move ◀○ or ○▶ to display only the addresses in the selected category. Move 📍 to change the user address book (Driver 1 or Driver 2).

Address Book

Up to 200 addresses can be stored to each address book of Driver 1 and Driver 2 separately.

If you have PIN-protected your address book, enter your PIN when prompted. Press  to select **OK**. PINs are optional.

 **PIN Numbers** P. 47

Any address book categories you create are also displayed.

 **Selecting an Address Book Category** P. 42

■ Adding an Address Book Entry

📍 **SETTINGS** button ▶ **Navi Settings** ▶ **Personal Info** ▶ **Address Book**

This section explains how to enter the name and address.



1. Move 📍 and rotate 🔄 to select **Add New Address**. Press 📍.

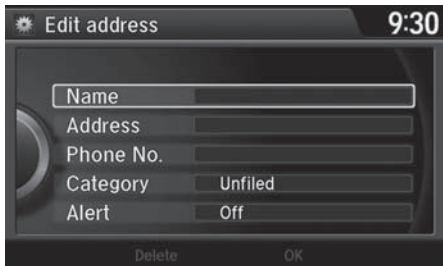

2. Rotate 🔄 to select an item. Press 📍.

The following items are available:

- **Name:** Edits the name of the entry.
- **Address:** Edits the address of the entry.
- **Phone No.:** Edits the phone number of the entry.
- **Category:** Specifies the category of the entry.

▣ Adding an Address Book Entry

If you do not give the address a name, one is automatically assigned (e.g., Address 001). You can re-enter, edit, or make changes to any entry. "Address" is the only required field.

- **Alert:** Alerts you when you approach the address entry.
On: Beeps and displays a message when your vehicle gets near the entry.
Off (factory default): Disables the feature.



3. Rotate to select **Name**. Press .
4. Enter a name or title. Move to select **OK**.
5. Rotate to select **Address**. Press .
6. Rotate to select an item for specifying the address. Press .

The following items are available:

- **Address:** Enter an address on the character input screen when prompted.
Address P. 92
- **Previous Destinations:** Select a previous destination.
Previous Destination P. 100
- **Current Position:** Select your current location.
- **Place Category:** Select a category to search for a place/landmark (e.g., Banking, Lodging).
Place Category P. 101
- **Local Search:** Sets a destination by using Local Search.
Local Search P. 103
- **Place Name:** Enter the name of a place/landmark.
Place Name P. 105
- **More Search Methods:** Displays additional search method entries.
Entering a Destination P. 90

Adding an Address Book Entry

When you use **Place Name** or **Place Category**, the phone number is automatically entered.

You can also add a phone number and category.

Continued

■ Editing an Address Book Entry

🔧 **SETTINGS** button ▶ **Navi Settings** ▶ **Personal Info** ▶ **Address Book**



1. Rotate to select the address to edit. Press .
2. Enter the name, address, phone number, and category fields.
 ▶ **Adding an Address Book Entry** P. 40
3. Move and rotate to select OK. Press .

▶▶ Editing an Address Book Entry

The entered contents are displayed on the Edit address screen.

■ Selecting an Address Book Category

🔧 **SETTINGS** button ▶ **Navi Settings** ▶ **Personal Info** ▶ **Address Book**

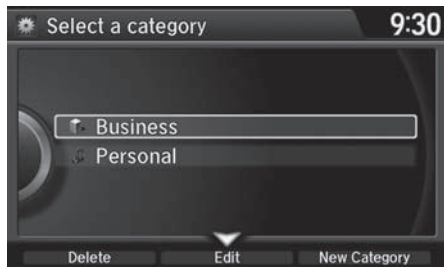



1. Rotate to select an address. Press .
 2. Rotate to select **Category**. Press .
 3. Rotate to select a category. Press .
- ▶ Create a category in advance.
 ▶ **Creating a New Category** P. 43

▶▶ Selecting an Address Book Category





Up to 100 categories (including “Unfiled”) can be stored to each address book of Driver 1 and Driver 2 separately.

If you delete a category that is used by other addresses, the category type for those addresses changes to “Unfiled.”

■ Creating a New Category

1. Move  and rotate  to select **New Category**. Press .
2. Enter a name and select an icon when prompted.
 - ▶ The created category is displayed in the list of categories.





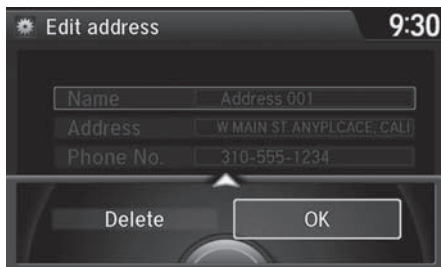

■ Deleting or Editing a Category

1. Move  and rotate  to select **Delete** or **Edit**. Press .
2. Delete an existing category, or change the name and icon.
 - ▶ The selected category to delete is indicated with a trash icon. Move  and rotate  to select **OK**.

■ Deleting an Address Book Entry

 **SETTINGS** button ▶ **Navi Settings** ▶ **Personal Info** ▶ **Address Book**



1. Rotate  to select the address to delete. Press .
2. Move  and rotate  to select **Delete**. Press .
3. Rotate  to select **Yes**. Press  to delete the address.

▣ Deleting an Address Book Entry

When you transfer the vehicle to a third party, delete all address book entries.

■ Setting Place Shortcuts

You can store up to six addresses previously stored in your Address Book, and a home address for your preset destinations.

■ Storing an address on the Shortcut



1. Select **Shortcuts**.
2. Select **Places**.
3. Select **Edit** or **No Entry**.
 - ▶ If you select **No Entry**, go to step 6.
4. Select **Add**.
 - ▶ All six preset icons appear.

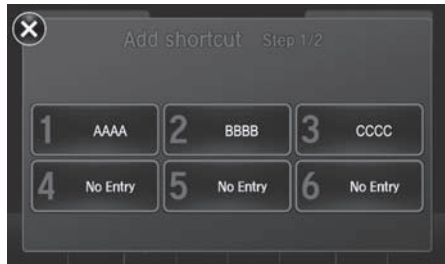

5. Select the preset number to which you want to store an address.
 - ▶ The screen changes to a list of addresses stored in your address book.

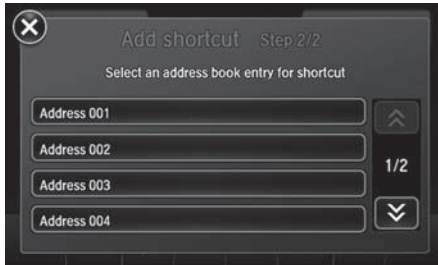

6. Select an address you want to store as a preset.

■ Deleting a preset address

1. Select Shortcuts.
2. Select Places.
3. Select Edit.
4. Select Delete.
5. Select the preset number with the destination you want to delete.

Home Address

🔗 **SETTINGS** button ▶ **Navi Settings** ▶ **Personal Info** ▶ **Edit Go Home**

Set a home address that you frequently use.



1. Edit the name, address, and phone number the same way as an address in the address book.

➤ **Adding an Address Book Entry** P. 40

2. Move 📍 and rotate 🔄 to select **OK**. Press 🗑️.

📍 Home Address

If you have PIN-protected your home addresses, enter your PIN when prompted. Press 🗑️ to select **OK**. PINs are optional.

➤ **PIN Numbers** P. 47

If your home street is not in the system database, park on the nearest verified street to your home. When entering the "Address" field, rotate 🔄 to select **Current Position** to use your current location as the home address and press 🗑️.

You can delete a home address if necessary. Move 📍 and rotate 🔄 to select **Clear Home Entry**. Press 🗑️. Rotate 🔄 to select **Yes**. Press 🗑️.

When you transfer the vehicle to a third party, delete all home addresses.

The home icon is shown on the map screen on the 1/20 and 1/8 mile (80 and 200 m) scales.

PIN Numbers

🔧 **SETTINGS** button ▶ **Navi Settings** ▶ **Personal Info** ▶ **PIN Number**

Set a four-digit PIN for protecting personal addresses and your home address. Once you set a PIN, you are prompted to enter it whenever you access a personal address or a home address.

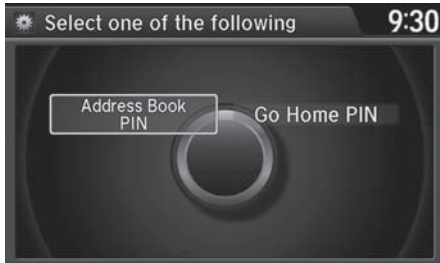

1. Rotate 🔄 to select the PIN to create. Press ⏹.

2. Rotate 🔄 to select a digit to enter. Press ⏹ to select **OK**. Repeat to enter a new four-digit PIN.
3. Re-enter the new PIN, when prompted, to confirm the number you just entered. Press ⏹ to select **OK**.
 - ▶ If you have not entered the same number both times, an "INCORRECT PIN" message is displayed. Enter your PIN again.

📖 PIN Numbers

PIN

Personal Identification Number (PIN) is a password used to access personal data.

PINs are optional. If you choose to use a PIN, keep a note of the number in a secure location. If you forget your PIN, a dealer will have to reset the navigation system and all of your stored information will be erased. The factory default is no PIN.



If you want to stop using a PIN, move 📏 to select **Turn Off PIN Entry**. Press ⏹.

Previous Destination

🔍 **SETTINGS** button ▶ **Navi Settings** ▶ **Personal Info** ▶ **Previous Destination**

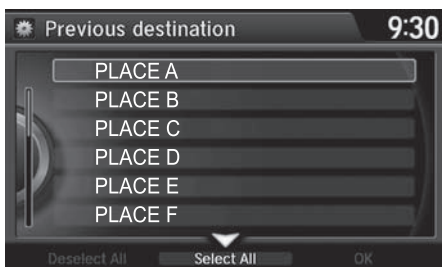

The navigation system maintains a list of your previously routed destinations as a shortcut for entering the same destination in the future. You can delete some or all of your previous destinations from the list.



1. Rotate  to select the destination to delete. Press .
 - ▶ Repeat the procedure as necessary.
 - ▶ Items to be deleted are indicated with a trash icon.





Trash icon

2. Move  and rotate  to select **OK** to delete the selected destinations.

▶▶ Previous Destination

Up to 50 destinations can be stored.



To cancel the selection of a previous destination, rotate  to highlight the destination again. Press  to de-select it.

Category History

 **SETTINGS** button ▶ **Navi Settings** ▶ **Personal Info** ▶ **Category History**

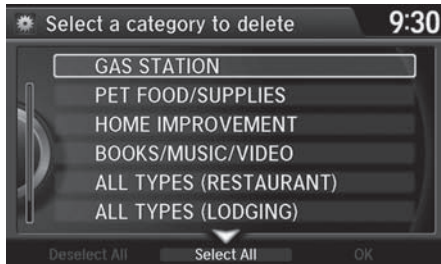

The navigation system maintains a list of your recently used place categories as a shortcut for selecting the same categories in the future. You can delete some or all of your recently used categories from the list.

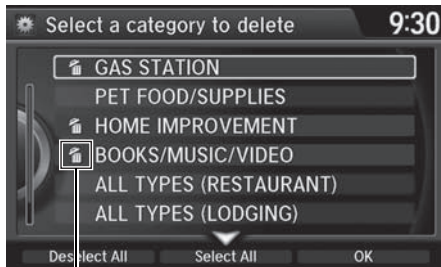

1. Rotate  to select the category to delete. Press .
 - ▶ Repeat the procedure as necessary.
 - ▶ Items to be deleted are indicated with a trash icon.





Trash icon

2. Move  and rotate  to select **OK** to delete the selected categories.

Category History

Up to 50 categories can be stored.

To cancel the selection of a category, rotate  to highlight the category again. Press  to de-select it.

Download POI

Import custom Points of Interest (POI) into the navigation system and set the POI as a destination. You can also add, edit, and delete POIs.

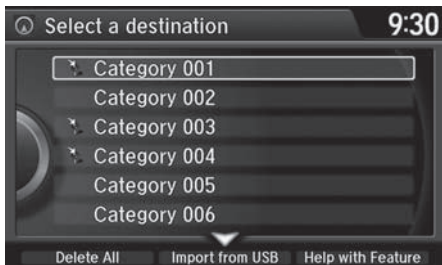

Importing POI Categories

MENU button (on map) ▶ **More Search Methods** ▶ **Download POI**

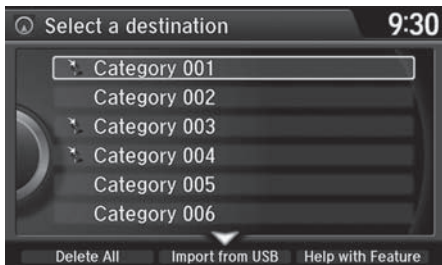

1. Connect a USB flash drive with stored POI data to the USB connector.
2. Move and rotate to select **Import from USB**. Press .

Importing POI Categories

For more information about connecting a USB flash drive.

Connecting a USB Flash Drive P. 207

POI data in csv and kml formats can be imported.

You can download POI data from various POI websites.

If you select **From AcuraLink**, you can download POI data from the AcuraLink® server.

AcuraLink® P. 266

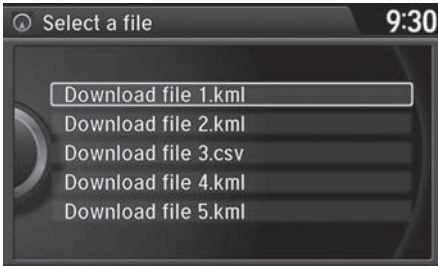

3. Rotate to select a category to import. Press .

Editing POI Categories

SETTINGS button ▶ **Navi Settings** ▶ **Personal Info** ▶ **Download POI**

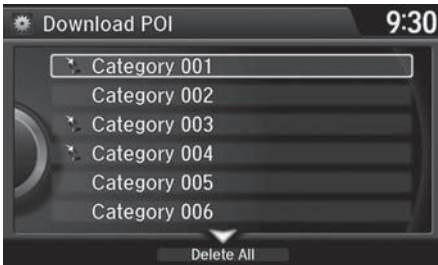



1. Rotate to select the downloaded POI category to edit. Press .

Editing POI Categories

If you select **From AcuraLink**, you can edit **Alert** only.



2. Rotate  to select an item. Press .



The following items are available:

- **Alert Setting:** Alerts you when you approach the places/landmarks in the category.
On: Beeps and displays a message when your vehicle gets near the places/landmarks in the category.
Off (factory default): Disables the feature.
- **Delete Category:** Deletes all places/landmarks and icon in the selected category.
- **Edit Icon:** Changes the category icon.

📍 SETTINGS button ► Navi Settings ► Routing

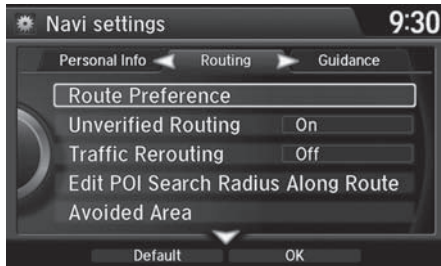
Choose various settings that determine the navigation system functionality during route calculation.



Rotate  to select an item. Press .

The following items are available:





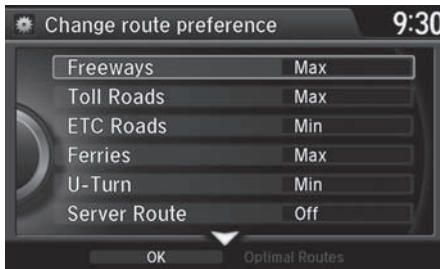

- **Route Preference:** Changes the route preferences (calculating method).
➤ **Route Preference** P. 54
- **Unverified Routing:** Sets whether you use the route guidance in unverified areas.
➤ **Unverified Routing** P. 56
- **Traffic Rerouting:** Sets whether you use automatic recalculation based on traffic information.
➤ **Traffic Rerouting** P. 58
- **Edit POI Search Radius Along Route:** Sets the distance from the route to find waypoints.
➤ **Edit POI Search Radius Along Route** P. 59
- **Avoided Area:** Specifies areas to avoid when calculating a route.
➤ **Avoided Area** P. 60

Route Preference

🔗 **SETTINGS** button ► **Navi Settings** ► **Routing** ► **Route Preference**

Change the route preference by selecting minimum or maximum driving methods.



1. Rotate  to select an item. Press .
2. Rotate  to select **Min** or **Max**. Press .
 - Repeat step 1 and 2 as necessary.
3. Move  to select **OK**. Press .

Route Preference

The calculated route may be the shortest route or the route you would choose. For safety reasons, the system generally applies the following rules to your route:

- Shortcuts through residential areas are avoided.
- Right turns are favored over left turns or U-turns.
- Time-restricted turns (turns prohibited at certain times of the day) are not used.

Check the ferry schedule when the calculated route includes ferry route.

ETC is short for the Electronic Toll Collection system.

Server Route

- You can view three routes distributed from AcuraLink®.
 - **Viewing the Routes** P. 117
- Set to **On** and select **Optimal route** to select your desired route.
 - **Optimal Routes** P. 55



Optimal Routes



 **SETTINGS** button ▶ **Navi Settings** ▶ **Routing** ▶ **Route Preference**

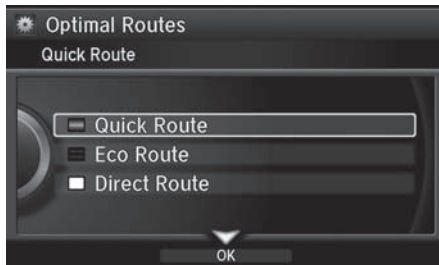
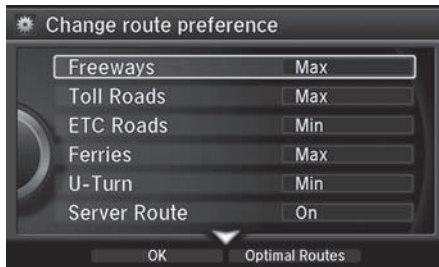

You can select desired routes by sorting the route list. The three top routes can be displayed on the **Select a route** screen.



 **Viewing the Routes** P. 117



1. Move  and rotate  to select **Optimal Routes**. Press .

2. Rotate  to select a list item to move. Press .

3. Rotate  to select a desired location. Press .

4. Move  and rotate  to select **OK**. Press .

Optimal Routes

Optimal Routes is a subscription service. For more information, contact an Acura dealer or visit owners.acura.com (U.S.) or www.myacura.ca (Canada).

Unverified Routing

🔗 **SETTINGS** button ► **Navi Settings** ► **Routing** ► **Unverified Routing**

Receive turn-by-turn map and voice guidance in unverified areas.



Rotate  to select **On** or **Off**. Press .

Differences	Off	On (factory default)
On or Off?	The driver wishes to manually navigate using the navigation map and choose the streets that lead to the destination.	The driver chooses to let the navigation system suggest possible routing, knowing that the guidance may not be accurate.
Route calculation	Route is usually longer, using verified roads whenever possible.	Route is shorter, but uses unverified (purple) streets that may not be accurate.

Unverified Routing

Unverified roads are found in rural areas, and typically include residential streets away from the center of a town. They may not be accurate, and can contain errors in location, naming, and address range.

Unverified roads are shown only when viewing the map in the 1/20, 1/8, 1/4, 1/2, 1 and 2 (mile) / 80, 200, 400, 800 (m), 1.6 and 3.2 (km) map scales.

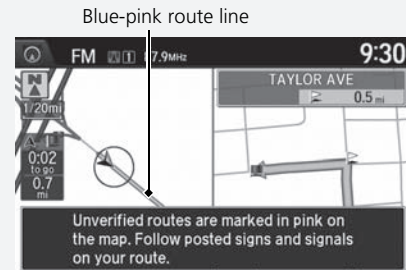
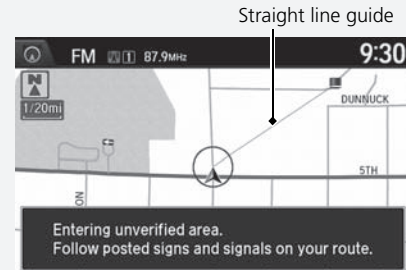

Differences	Off	On (factory default)
Route line	<p>The route line uses verified streets only (when possible). If Straight Line Guide is set to On, a pink vector line is displayed on the map that continually points to your destination.</p> <p>▣ Straight Line Guide P. 78</p>	<p>A blue-pink route line highlights suggested unverified streets on the map while traveling to your destination.</p>
Cautionary messages	<p>Cautionary pop-up screens and voice announcements remind you to obey all traffic restrictions when starting route guidance, approaching an unverified area, and entering an unverified street.</p>	<p>Cautionary pop-up screens and voice announcements remind you to obey all traffic restrictions when entering an unverified street.</p>
Guidance (map/voice)	<p>There is no turn-by-turn map or voice guidance.</p>	<p>Voice guidance commands end with the phrase “if possible” to remind you to verify all traffic restrictions.</p>
Directions list	<p>A direction list is typically not available. However, depending on your route, directions are provided to help you reach the first available verified road.</p>	<p>A direction list is provided showing street names and turn symbols in pink.</p>



Traffic Rerouting

🔗 **SETTINGS** button ► **Navi Settings** ► **Routing** ► **Traffic Rerouting**

A faster route can be calculated based on continuously updated traffic information.

➤ **Traffic Rerouting™** P. 130



Rotate  to select an option. Press .

The following options are available:

- **On:** The system reroutes automatically based on traffic information.
- **Off** (factory default): Disables the feature.

☒ Traffic Rerouting

Traffic Rerouting requires an AcuraLink Real-Time Traffic™ subscription.

➤ **AcuraLink®** P. 266

Automatic traffic rerouting may not provide a detour route depending on circumstances.

Edit POI Search Radius Along Route





 **SETTINGS** button ► **Navi Settings** ► **Routing** ► **Edit POI Search Radius Along Route**

Select the distance from your highlighted route line (on either side of your route) that the system will search for a waypoint.

 **Adding Waypoints** P. 135

You can specify a different search distance for freeways/highways and surface streets.



1. Rotate  to select an item. Press .
2. Rotate  to select a search distance. Press .

The following items are available:

- **On Freeways (U.S.)/On highways (Canada):** 1, 2, 5, or 10 miles (1.6, 3, 8, or 16 km) can be set. Factory default is 2 miles (3 km).
- **On Surface Streets:** 1/2, 1, 2, or 5 miles (0.8, 1.6, 3, or 8 km) can be set. Factory default is 1/2 mile (0.8 km).

Edit POI Search Radius Along Route

The search distance does not affect the search range used for the Find Nearest voice commands (e.g., say  "Find nearest gas station").

Avoided Area

📍 **SETTINGS** button ► **Navi Settings** ► **Routing** ► **Avoided Area**

Specify up to five areas to avoid (e.g., road construction, closures), if possible, when the system calculates routes to your destination.



1. Move 📍 and rotate 🔄 to select **New Area**, or rotate 🔄 to select an existing area to edit.



2. Rotate 🔄 to select **Name** to label the area to avoid. Press 📍.
3. Enter a name or title. Move 📍 to select **OK**.
4. Rotate 🔄 to select **Area** to define the area to avoid. Press 📍.

The following options are available (after an area is set):

- **View Area:** Displays the selected avoided area on the map.
- **Delete:** Deletes the selected avoided area.

📍 Avoided Area



The maximum size of one side of an “avoid area” is approximately 1/2 mile (800 m).

If your selected area contains a freeway/highway, you are asked “Do you want to avoid freeways (highways)?” Answering “No” allows you to use a route through an avoid area on a freeway/highway without any pop-up messages.

You can select areas to avoid, however you cannot select roads or areas that you want the system to use for routing.

You can enter up to 25 characters for the name.





5. Rotate  to select a method for specifying the area. Press .

The following options are available:

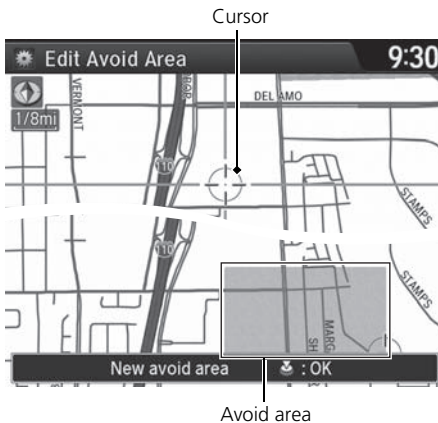
- **Address:** Specify the general area by entering an address.
 - **Address** P. 92
- **Map Input:** Specify the general area by map input.
 - **Map Input** P. 112



6. If you select **Map Input**, scroll the map to position the cursor over your desired start point, adjusting the map scale as necessary. Press  to mark the start point.
 - ▶ To redo the area selection, press the **BACK** button.
7. Scroll the map to “draw” the area. Press  to mark the end point.
8. Press  to select **OK**.
 - ▶ The area you specify is displayed in the list of areas to avoid.



▶▶ Avoided Area

Avoid area can be set in the 1/20, 1/8, or 1/4 mile (80, 200, or 400 m) map scales.

📍 SETTINGS button ► Navi Settings ► Guidance

Choose various settings that determine the navigation system functionality during route guidance.



Rotate  to select an item. Press .

The following items are available:

- **Guidance Mode:** Sets whether to display only the map screen or a split map-guidance screen.
 - **Guidance Mode** P. 63
- **Street Name Guidance** (US models): Sets whether to read out the street names during voice guidance.
 - **Street Name Guidance** P. 65
- **Non-map screens:** Sets whether the guidance screen interrupts the screen display.
 - **Non-map screens** P. 66
- **Guidance Point:** Sets whether to display the guidance information to the destination or the next waypoint.
 - **Guidance Point** P. 67
- **Estimated Time:** Sets whether to display the remaining time or arrival time to the guidance point.
 - **Estimated Time** P. 68

Guidance Mode

📍 **SETTINGS** button ▶ **Navi Settings** ▶ **Guidance** ▶ **Guidance mode**

Select the display mode for the map and guidance screens.



Rotate 🔄 to select an option. Press 📍.

The following options are available:

- **Map** (factory default): Displays only the map screen. When you approach a guidance point, the next guidance point appears.

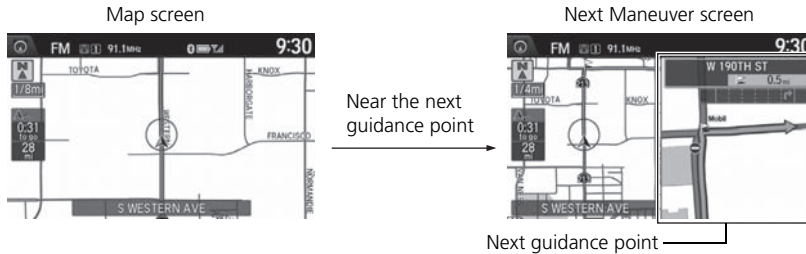

Guidance Mode

The guidance mode can also be selected from the map menu.

➤ **Map Menu** P. 125

Press the NAV button to switch between the map, next guidance direction, and a list of guidance directions.

Turn-by-Turn Directions

The next guidance point appears on the multi-information display.

➤ **Turn-by-Turn Directions** P. 10

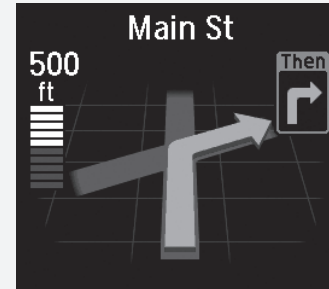

You can turn this feature on or off using the multi-information display. See the Owner's Manual for instructions.

- **Direction List:** Displays the map and direction list simultaneously on the map screen. When you approach a guidance point, the next guidance point appears.

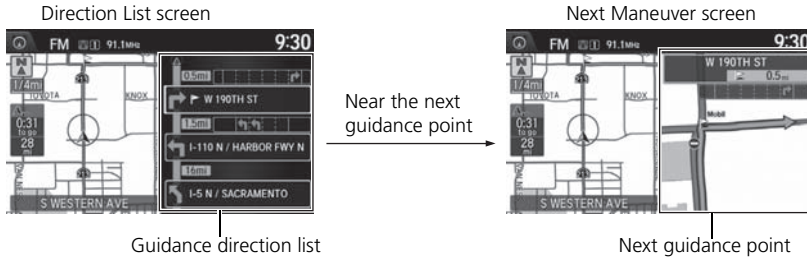

- **Next Maneuver:** Displays the map and next guidance point simultaneously on the map screen.

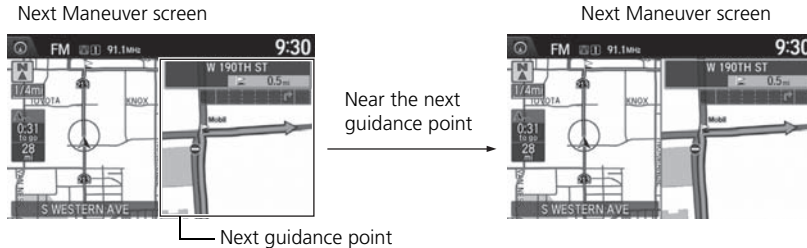



Street Name Guidance

 **SETTINGS** button ► **Navi Settings** ► **Guidance** ► **Street Name Guidance**

The navigation system includes the street names during voice guidance (e.g., “Turn right on Main Street”).



Rotate  to select an option. Press .

The following options are available:

- **On** (factory default): Voice guidance includes the street names.
- **Off**: Disables the feature.

Street Name Guidance

This feature is only available when the system language is set to **English**.

This feature may not be available in non-English speaking areas.



This function is available on U.S. models only.

Non-map screens

 **SETTINGS** button ▶ **Navi Settings** ▶ **Guidance** ▶ **Non-map screens**

The navigation system temporarily interrupts the screen display to view the guidance screen as you approach a guidance point.



Rotate  to select an option. Press .

The following options are available:



- **On:** The guidance screen interrupts other mode screens (e.g., audio, phone, etc, except the rear view camera mode).
- **Off** (factory default): Disables the feature.

Guidance Point

🔧 **SETTINGS** button ▶ **Navi Settings** ▶ **Guidance** ▶ **Guidance Point**

Set the guidance point to display on the map screen.



Rotate  to select an option. Press .

The following options are available:



- **Destination** (factory default): Displays the remaining/arrival time and distance to the destination.
- **Next Point**: Displays the remaining/arrival time and distance to the next waypoint.

Estimated Time

🔗 **SETTINGS** button ▶ **Navi Settings** ▶ **Guidance** ▶ **Estimated Time**

Select the estimated time to display on the screen.



Rotate  to select an option. Press .



The following options are available:

- **Arrival**: Displays the arrival time to the destination or the next waypoint.
- **Remaining** (factory default): Displays the remaining time to the destination or the next waypoint.

SETTINGS button ► Navi Settings ► Map

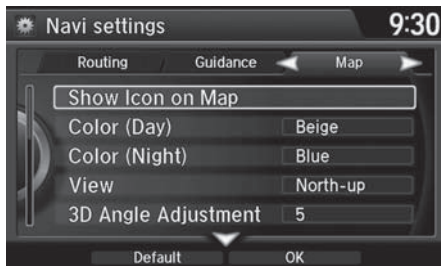
Select the landmark icons to display on the map, change the orientation of the map, display your current location, and learn the meaning of the icons, colors, and symbols displayed on the map.



Rotate  to select an item. Press .

The following items are available:

- **Show Icon on Map:** Selects the icons to display on the map.
 - **Showing Icons on Map** P. 71
- **Color (Day):** Selects the color of the map for the Day mode.
 - **Color** P. 73
- **Color (Night):** Selects the color of the map for the Night mode.
 - **Color** P. 73
- **View:** Selects the map orientation (**North-up**, **Heading-up**, or **3D map**).
 - **View (Map Orientation)** P. 76
- **3D Angle Adjustment:** Adjusts the viewing angle for the 3D map.
 - **3D Angle Adjustment** P. 77
- **Straight Line Guide:** Sets whether to display a straight guideline to the destination or waypoint.
 - **Straight Line Guide** P. 78



- **Current Location:** Displays and saves your current location.
 - ▶ **Current Location** P. 79
- **Map Legend:** Displays an overview of the map features.
 - ▶ **Map Legend** P. 80
- **Display Tracking:** Sets whether to display the tracking dots on the map.
 - ▶ **Display Tracking** P. 84
- **Delete Tracking:** Deletes the tracking dots on the map.
 - ▶ **Deleting Tracking Dots** P. 85
- **Correct Vehicle Position:** Adjusts the position of the vehicle on the map.
 - ▶ **Correct Vehicle Position** P. 86
- **System Device Information:** Views database, software, device, and vehicle identification information.
 - ▶ **System Device Information** P. 280
- **Map Data Update:** Checks the map data update status when updating the map database.
 - ▶ **Map Data Update** P. 280

Showing Icons on Map



 **SETTINGS** button ► **Navi Settings** ► **Map** ► **Show Icon on Map**

Select the icons that are displayed on the map.





1. Rotate  to select an item. Press .





2. Rotate  to select an option. Press .

► Repeat step 1 and 2 as necessary.

3. Move  to select OK. Press .

The following options are available:

- **All On:** Displays the landmark icons.
 **Map Screen Legend** P. 9
- **Customize:** Fine-tunes the icon display.
 **Fine-tuning the Icons** P. 72
- **Off:** Hides the landmark icons.

Showing Icons on Map

You can display or hide the icons using voice commands on the Voice Portal screen (e.g., say  "Display hospital").

 **Map Display Commands** P. 314



If you have PIN-protected your address book, enter your PIN when prompted. Move  to select OK. PINs are optional.

 **PIN Numbers** P. 47



Fine-tuning the Icons

Icons in some categories can be fine-tuned to display or hide.

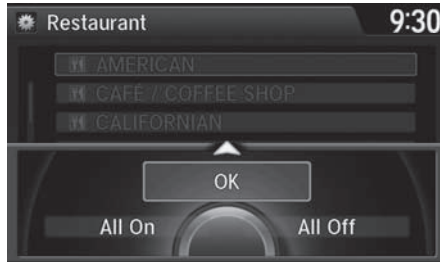

1. Rotate  to select the icons to display on the map. Press .
 - ▶ Pressing  toggles the icon display on or off.
 - ▶ Repeat the procedure as necessary.



2. Move  and rotate  to select OK. Press .

Color

Set separate map colors for Day and Night modes.

Color (Day)

SETTINGS button ▶ Navi Settings ▶ Map ▶ Color (Day)

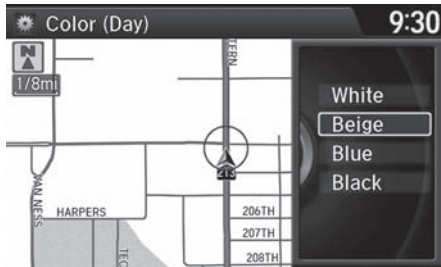

Rotate  to select a color for the Day mode. Press .

Color (Night)

SETTINGS button ▶ Navi Settings ▶ Map ▶ Color (Night)

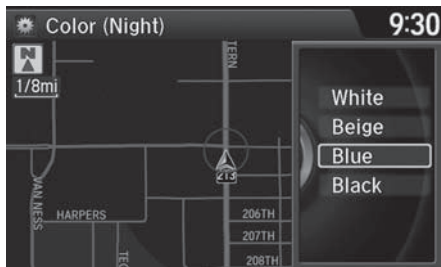

Rotate  to select a color for the Night mode. Press .

Color (Day)

The factory default is set to **Beige**.





Color (Night)

The factory default is set to **Blue**.

■ Switching Display Mode Manually

Set the screen brightness separately for Day and Night modes. Press the  (Display mode) button to cycle through the display modes (Day to Night to Off).





1. Press the  button.
 - ▶ The Brightness bar is displayed for a few seconds.
 - ▶ Rotate  to adjust the brightness. Press .
2. Press the  button again.
 - ▶ Repeat the procedure to switch the display modes.

☒ Switching Display Mode Manually

A visual guide helps you see the difference between Day and Night modes.

☒ **Day or Night Mode** P. 10

■ Illumination	■ Priority	■ Operation
 button	1	Selects Day, Night, or Off display mode. This button has the highest priority and overrides all other display control adjustments listed below. Remember: Once you press this button, you assume full manual control of the display mode until the power mode is set to VEHICLE OFF (LOCK).
Sunlight sensor (see your Owner's Manual for location)	2	If the sunlight sensor detects daylight and the headlights are turned on, the system automatically overrides the Night display and displays the Day display mode. Remember: If desired, use the a  button to override this automatic choice.

Illumination	Priority	Operation
Dash illumination adjustment buttons (see your Owner's Manual for location)	3	When headlights are turned on, and you wish to have the Day display mode, adjust the illumination to the full brightness setting (beeps). Remember: Adjust the dash brightness back to mid-range to allow auto switching by sensing the headlights are on or off.
Headlights (Auto/On/Off)	4	When turned on, the display changes to Night display mode. The previous three controls listed above can "cancel" this function. Remember: Use the a  button, or adjust the dash illumination to full brightness, to set the display to your desired choice.
Screen color choice	N/A	The user can select the color of the screen that will be displayed for the Day and Night display modes described above.

View (Map Orientation)

📍 **SETTINGS** button ▶ **Navi Settings** ▶ **Map** ▶ **View**

Select the map orientation.



Rotate 📶 to select an option. Press 📶.

The following options are available:

- **North-Up:** Displays the map with North always pointing up.
- **Heading-Up:** Displays the map so that the direction you are traveling is always pointing up.
- **3D Map:** Displays the bird's eye view map.

📶 View (Map Orientation)

📶 "Display Heading up" (on Voice Portal screen),
📶 "Display North up" (on Voice Portal screen), 📶
"Display 3D map" (on Voice Portal screen)

The red arrow in the symbol always points North.

Heading-up and 3D map view switch to the North-up view on the maximum map scale.

The bird's eye view map switches to the Heading-up map while scrolling the map.

The viewing angle for the bird's eye view can be adjusted.



📶 **3D Angle Adjustment** P. 77

3D Angle Adjustment

📍 **SETTINGS** button ▶ **Navi Settings** ▶ **Map** ▶ **3D Angle Adjustment**

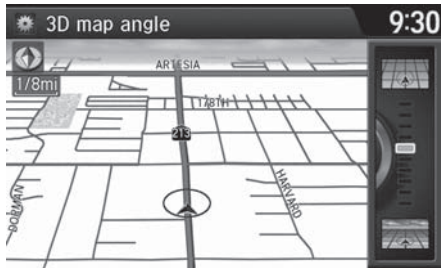
Adjust the viewing angle.





Rotate  to adjust the angle. Press .

Straight Line Guide

🔗 **SETTINGS** button ▶ **Navi Settings** ▶ **Map** ▶ **Straight Line Guide**

Set whether to display a straight guideline to the destination or waypoint.



Rotate  to select an option. Press .

The following options are available:

- **On** (factory default): Displays the straight guideline on the map.
- **Off**: Disables the feature.

Current Location

📍 **SETTINGS** button ▶ **Navi Settings** ▶ **Map** ▶ **Current Location**

Display and save your current location for future use as a destination. The address, latitude, longitude, and elevation of your current location are displayed.

■ **To save your current location in the address book:**



1. Press 📍 to select **Address Book**.
▶ Move ⏪ to scroll the map as necessary.
2. Edit the name, phone number, and category.
➡ **Address Book** P. 39
3. Move 📍 and rotate 🔄 to select **OK**. Press 📍.

📍 **Current Location**

📍 "Display Current Location" (on Voice Portal screen)

You can also save the current location by saying 📍 "Register the Current Location".

If you have PIN-protected your address book, enter your PIN when prompted. Press 📍 to select **OK**. PINs are optional.

➡ **PIN Numbers** P. 47

The elevation is not displayed if the system is receiving insufficient GPS information. When elevation is displayed, it may differ with roadside elevation signs by ±100 ft (±30 m) or more.

Saving your current location does not change or cancel your current route.

Map Legend

🔗 **SETTINGS** button ▶ **Navi Settings** ▶ **Map** ▶ **Map Legend**

See an overview of the map lines, areas, routes, traffic information, and navigation icons.



Move ◀○ or ○▶ select an item.

▶ The system displays the map legend.

Map Legend

A visual guide helps you see the map legend.

▶ **Map Screen Legend** P. 9

▶ **AcuraLink Real-Time Traffic™** P. 14

■ Map Scale and Functions

The functions that are available from the map screen depend on the map scale.

Function	page	Map Scale (top: mile, bottom: metric)											
		1/20	1/8	1/4	1/2	1	2	5	15	50	150	350	1000
		80	200	400	800	1.6	3.2	8	24	80	240	560	1600
Icon display													
Landmark icon	9	✓	✓										
Exit info.	9			✓	✓	✓							
One-way traffic	9	✓											
Waypoint "flag"	10	✓	✓	✓	✓	✓	✓	✓	✓	✓	✓	✓	✓
Traffic incident	14	✓	✓	✓	✓	✓	✓	✓					
Map orientation													
Heading-up	76	✓	✓	✓	✓	✓							
North-up	76	✓	✓	✓	✓	✓	✓	✓	✓	✓	✓	✓	✓
3D map	76	✓	✓	✓	✓	✓	✓	✓	✓	✓	✓	✓	
Others													
Tracking dots	122	✓	✓	✓	✓								
Unverified road	9	✓	✓	✓	✓	✓	✓						
Map features	9	✓	✓	✓	✓	✓	✓	✓	✓	✓	✓	✓	
Avoid areas	60	✓	✓	✓									
Traffic speed	14	✓	✓	✓	✓	✓	✓	✓					

Continued

☒ Map Scale and Functions

You can change the map scale using voice commands on the Voice Portal screen (e.g., say  "Display 2 mile (3 km) scale").

 **Map Scale Commands** P. 314

You can change between **mile** or **km**.

 **Unit Settings** P. 33

■ Map Icons and Functions

Display or hide all icons on the map screen, with the exception of Honda/Acura Dealer icons which are always shown.

■ Landmark icon

Type	Icon display control	Icon selectable	Icon searchable
Honda/Acura dealer	Always on	Yes	Yes
Hospital	Yes	Yes	Yes
School	Yes	Yes	Yes
ATM	Yes	Yes	Yes
Gas station	Yes	Yes	Yes
Restaurants	Yes	Yes	Yes
Post office	Yes	Yes	Yes
Grocery store	Yes	Yes	Yes
Hotel/Lodging	Yes	Yes	Yes
Police station	No icon	No	Yes
Shopping, Tourist attraction, Bank	No icon	No	Yes
Parking garage	Yes	Yes	Yes
Parking lot	Yes	Yes	Yes
Freeway/Highway exit info.	Yes	Yes	No

▣ Map Icons and Functions

You can display or hide the icons using voice commands on the map screen (e.g., say  "Display hospital").

▣ **Map Scale Commands** P. 314

Some icons, like police stations, are not shown, but you can still locate the nearest one with the Find Nearest voice command (e.g., say  "Find nearest police station").

▣ **Unit Settings** P. 33

Icon display control

Icons that can be displayed or hidden using the Interface Dial or voice command.

Icon selectable

Icons that can be selected as a destination using the Interface Dial.

Icon searchable

Icons that can be searched using the  Find Nearest voice command.

■ Traffic icon

Type	Icon display control	Icon selectable	Icon searchable
Traffic incident	Yes	No	Yes

☒ Traffic icon

When you use the Interface Dial to position the cursor (round red circle) over the traffic incident icon, you can view the summary of the incident.



Press  on the traffic incident icon to view a pop-up message describing the incident in detail.

Display Tracking

🔗 **SETTINGS** button ► **Navi Settings** ► **Map** ► **Display Tracking**

The navigation system can be set to display white tracking dots (“breadcrumbs”) on the map screen.



Rotate  to select an option. Press .

The following options are available:

- **On:** The system displays the white tracking dots.
 ➡ **Tracking Dots** P. 122
- **Off** (factory default): Disables the feature.

Deleting Tracking Dots

 **SETTINGS** button ▶ **Navi Settings** ▶ **Map** ▶ **Delete Tracking**



Rotate  to select **Yes**. Press .

Deleting Tracking Dots

When you transfer the vehicle to a third party, delete the tracking dots.

Correct Vehicle Position

🔗 **SETTINGS** button ▶ **Navi Settings** ▶ **Map** ▶ **Correct Vehicle Position**

Manually adjust the current position of the vehicle as displayed on the map screen if the position appears to be incorrect.

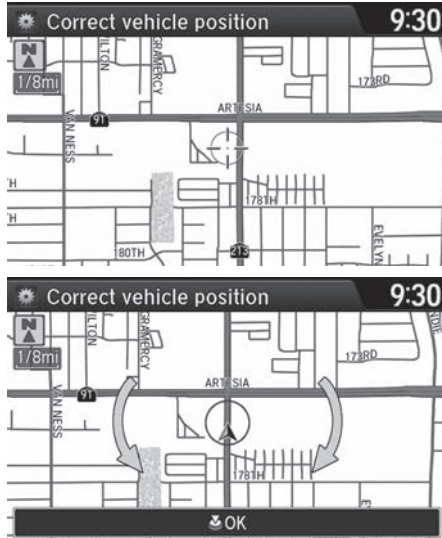

1. Put the vehicle in Park.
2. Rotate 🔄 to select **Correct Vehicle Position**. Press ⌚.
3. Scroll the map to position the cursor over at your correct position. Press ⌚.
4. Rotate 🔄 to position the arrowhead in the correct direction the vehicle is facing.
5. Press ⌚ to select **OK**.

🔗 Correct Vehicle Position

An apparent position error can occur where buildings, tunnels, and other objects block or reflect the GPS signals, forcing the system to use "dead reckoning" to determine your location and direction.

Using this function to adjust vehicle position is not recommended. When the system reacquires a GPS signal, it will automatically place the vehicle in the correct location.

If you continually have to adjust the vehicle position, you may have problems with the GPS reception or there may be database errors.





➔ **System Limitations** P. 302

Defaulting All the Settings

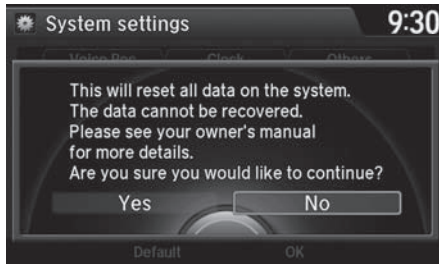
 **SETTINGS** button ► **System Settings** ► **Other Factory Data Reset**

Reset all the menu and customized settings as the factory defaults.



1. Rotate  to select **Yes**. Press .
► The confirmation message will appear.
2. Rotate  to select **Yes**. Press again to reset the settings.
► The confirmation message will appear. Press  to select **OK**.

Defaulting All the Settings

When you transfer the vehicle to a third party, reset all settings to default and delete all personal data.

Changing the Screen Settings

Adjusts the screen settings of the On Demand Multi-Use Display™.



1. Select **More**.
2. Select **Screen Settings**.
3. Use **+**, **-** or other icons to adjust the setting.
 - ▶ Use the / icons to turn the page.
 - ▶ Select to go back to the previous screen.

The followings are adjustable screen settings:

- **Sync Display Brightness:** Selects whether the screen brightness synchronizes with the instruments panel brightness.
- **Brightness:** Adjusts the screen's brightness.
- **Contrast:** Adjusts the screen's contrast.
- **Black Level:** Adjusts the screen's black level.
- **Display:** Changes between the daytime or nighttime modes.
- **Beep:** Turns on or off the beep that sounds every time you touch the screen.
- **Keyboard:** Changes the on-screen keyboard from the alphabetical order to the qwerty type.
- **Vibration:** Turns on or off the vibration when you touch the screen.
- **Fade Timer:** Sets the screen black out timing.

Navigation



This section describes how to enter a destination, select a route to take, and follow the route to your destination. It also describes how to change your route or destination along the way.



Entering a Destination	90	Calculating the Route	115	Adding Waypoints	135
Address	92	Viewing the Routes	117	Editing the Destination List	139
Address Book	99	Driving to Your Destination	118	Taking a Detour	141
Previous Destination	100	Viewing the Route	118	Avoiding Streets	141
Place Category	101	Listening to Voice Guidance	123	Changing Your Destination	142
Local Search	103	Reaching a Waypoint	124	Find Nearest Place	142
Place Name	105	Map Menu	125	Selecting a Destination on the Map	143
Place Phone Number	108	Displaying the Map Menu	125	Entering a New Destination	144
Download POI	109	Hide Traffic Flow	127	Resuming Your Trip	145
Scenic Route	110	Directions	128		
Intersection	111	Traffic Rerouting™	130		
Map Input	112	Changing Your Route	133		
Coordinate	114	Pausing the Route	134		
		Canceling the Route	134		

Entering a Destination

 **MENU** button (on map)

This section describes how to enter a destination for route guidance.



Rotate  to select an item. Press .

▶ Select **More Search Methods** to display additional menu entries.



The following items are available:

- **Address**: Sets a destination by entering an address.
▶ **Address** P. 92
- **Address Book**: Sets a destination by selecting an address stored in your Address Book.
▶ **Address Book** P. 99
- **Previous Destination**: Sets a destination by selecting a previous destination.
▶ **Previous Destination** P. 100

▶▶ Entering a Destination

 "Display Navigation"

If you press the **MENU** button when en route, the Route Option screen is displayed.

▶ **Changing Your Route** P. 133

Prior to departure, you can set areas along your route to avoid.

▶ **Avoided Area** P. 60



- **Go Home:** Sets your home address as a destination.
 ▶ **Going Home** P. 11
- **Place Category:** Sets a destination by selecting a place/landmark.
 ▶ **Place Category** P. 101
- **Local Search:** Sets a destination by using Local Search.
 ▶ **Local Search** P. 103
- **Place Name:** Sets a destination by entering a place name.
 ▶ **Place Name** P. 105
- **Place Phone Number:** Sets a destination by entering the phone number of a place/landmark.
 ▶ **Place Phone Number** P. 108
- **Download POI:** Sets a destination by using a list of the imported POI (category and places) data you created.
 ▶ **Download POI** P. 109
- **Scenic Route:** Sets a destination by using a list of scenic roads for each state or province (U.S. and Canada only).
 ▶ **Scenic Route** P. 110
- **Intersection:** Sets a destination (intersection) by entering two streets.
 ▶ **Intersection** P. 111
- **Map Input:** Sets a destination by scrolling through the map.
 ▶ **Map Input** P. 112
- **Coordinate:** Sets a destination by entering latitude and longitude.
 ▶ **Coordinate** P. 114

Address

MENU button ▶ Address

Enter an address to use as the destination. The state or province you are currently in is displayed (e.g., California).



Rotate  to select an item. Press .



The following items are available:

- **City:** Selects your destination city.
 - ▶ **Selecting a City** P. 95
- **Street:** Selects your destination street.
 - ▶ **Selecting a Street** P. 96
- **House Number:** Enters the house number to select the street.
 - ▶ **Selecting a Street by House Number** P. 98
- **ZIP Code (U.S.)/Postal Code (Canada):** Enters the zip code or postal code to select the city.
 - ▶ **Selecting a City by Zip Code or Postal Code** P. 94
- **Change State (U.S.)/Change Province (Canada):** Selects the state or province.
 - ▶ **Selecting the State or Province** P. 93

▶▶ Address

U.S. models

Using Voice Command (English only)



You can say the **entire** address at once using voice commands. Say  "Address" on the Voice Portal screen, then say the entire address. For example, "1-2-3-4 Main Street, Los Angeles, California." The system interprets the address. Say  "Set as destination" to begin the route.

The system language needs to be set in English.

■ Selecting the State or Province

 **MENU** button ▶ **Address** ▶ **Change State/Change Province**



Rotate  to select a state or province from the list. Press .

☒ Selecting the State or Province

Move ◀○ or ○▶ to select the following areas:

- **USA** for the U.S. mainland, Alaska, Hawaii, and Puerto Rico
- **Canada**
- **Mexico**

■ Selecting a City by Zip Code or Postal Code



 **MENU** button ▶ **Address** ▶ **ZIP Code/Postal Code**



1. Enter the zip code or postal code of your destination.

2. Move  to select **OK**. Press .



3. Rotate  to select the destination city from the list. Press .

▶ Next, you are prompted to enter a street name.

 **Selecting a Street** P. 96

▣ Selecting a City by Zip Code or Postal Code

If your city is not listed, it may be part of a larger metropolitan area. Try entering the street first.

Selecting a City

MENU button ▶ Address ▶ City

The name of the city where you are currently located is displayed.

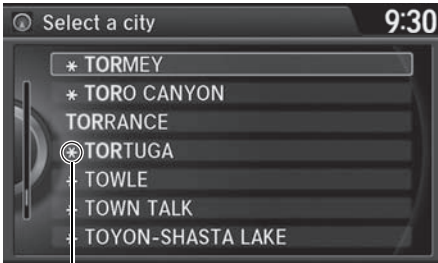

Non-detailed area mark: Try entering the street first and then select the city.

1. Enter the name of a different city, or move to select **OK** for the current city. Press .

2. Rotate to select your destination city from the list. Press .

▶ A list of matching hits is automatically displayed after you enter several letters, with the closest match at the top of the list. Matching letters are highlighted.

▶ Next, you are prompted to enter a street name.

▶ **Selecting a Street** P. 96

Selecting a City

Vehicle position may not be displayed when:

- The automobile is traveling off-road.
 - The vehicle position data cannot be updated.
- You do not need to enter spaces or symbols (e.g., &, -, %). Partial matches are supported (e.g., "ANGELES" to find "LOS ANGELES").

If your city is not listed, it may be part of a larger metropolitan area. Try entering the street first.

U.S. models

Using Voice Command (English only)

Say "City" on the Find address by screen, and the following screen is displayed:



- Say "Current City" to select your current location, or say the name of a different city.
- The Say city name screen is not displayed when your vehicle is in Puerto Rico or Mexico.

■ Selecting a Street

📍 MENU button ▶ Address ▶ Street



1. Enter the name of your destination street.

▶ Do not enter the street type (e.g., street, road, avenue) or direction (e.g., north, south, east, west).

▶ Move 📍 to select **OK** to display a list of streets. Press ⏸.

2. Rotate 🔄 to select your destination street from the list. Press ⏸.

▶ A list of matching hits is automatically displayed after you enter several letters, with the closest match at the top of the list. Matching letters are highlighted.

▣ Selecting a Street

When entering the names of major freeways/highways, you can use the following abbreviations. For interstates, use an "I" (e.g., I-10). For U.S. freeways, use "US" (e.g., US-18). For state freeways, use the two-character state designation (e.g., CA-101). For county roads, use the appropriate designation (e.g., G-2). For Trans-Canada and Provincial highways, use "Hwy" (HWY-7). For County roads, use "CR" (CR-32). For Regional Roads, use "RR" (RR-5).

If you did not select a city first and there is more than one city with the specified street, a list of cities is displayed.



Rotate 🔄 to select the desired city from the list. Press 📍.



3. Enter the street number.
 - ▶ Only valid street numbers can be entered.
4. Move to select OK. Press .
5. Set the route to your destination.

➤ **Calculating the Route** P. 115

▶▶ Selecting a Street

U.S. models

Using Voice Command (English only)

Say "Street" on the Find address by screen, and the following screen is displayed:

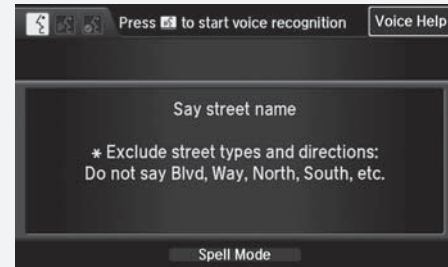

- Say the name of your destination street, and say the street number as a string of individual numbers.
 - Set the route to your destination.
- **Calculating the Route** P. 115
- The Say street name screen is not displayed when your vehicle is in Puerto Rico or Mexico.

■ Selecting a Street by House Number

📍 MENU button ▶ Address ▶ House Number







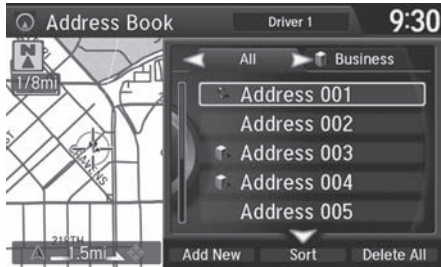

1. Enter the house number.
 - ▶ Only a valid house number can be entered.
2. Move 📍 to select **OK**. Press 🔄.
 - ▶ If you did not yet select a street name, enter a street name when you are prompted.
3. Rotate 🔄 to select your destination street from the list. Press 🔄.
 - ▶ Select a city when you are prompted.
4. Set the route to your destination.
 - ▶ **Calculating the Route** P. 115

Address Book

 **MENU** button ▶ **Address Book**

Select an address stored in your address book to use as the destination.





1. Rotate  to select your destination from the list. Press .
2. Set the route to your destination.
 - ▶  **Calculating the Route** P. 115
 - ▶ Move  or  to display only the entries in the categories you have created.
 - ▶  **Selecting an Address Book Category** P. 42

 **Address Book**

If you have PIN-protected your address book, enter your PIN when prompted. Press  to select **OK**. PINs are optional.

▶  **PIN Numbers** P. 47

Move  and rotate  to select the following items:



- **Add New Address:** Adds an entry to the address book.
 - ▶  **Adding an Address Book Entry** P. 40
- **Sort:** Selects **Sort by Name** or **Sort by Distance**.
- **Delete All:** Deletes all entries in the address book.
- **Driver 1 or Driver 2:** Displays the address book for the selected user.

Previous Destination

MENU button ▶ Previous Destination

Select an address from a list of your 50 most recent destinations to use as the destination. The list is displayed with the most recent destination at the top.



1. Rotate  to select a destination from the list. Press .
2. Set the route to your destination.
 **Calculating the Route** P. 115

Previous Destination

If **Previous Destination** is grayed out, there are no previous destinations entered.

Your home address and addresses stored in your address book are not added to the list of previous destinations.

Move  and rotate  to select **Delete All** to delete all previous destinations.

You can delete unwanted previous destinations from the list.



 **Previous Destination** P. 48

Place Category



 **MENU** button ▶ **Place Category**

Select the category of a place (e.g., Banking, Lodging, Restaurant) stored in the map database to search for the destination.

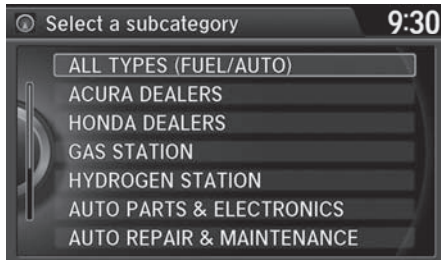

1. Rotate  to select a category. Press .



2. Rotate  to select a subcategory. Press .
 **List of Categories** P. 325

Place Category

This option is convenient if you do not know the exact name of a place or if you want to narrow down the number of matches returned for places with a common name.



Move  to select **Category History** to access your recently used place categories. Up to 30 categories can be stored.

You can also delete your recently used place categories.

 **Category History** P. 49

Search POI Categories helps you to search the subcategory. When you enter a keyword and select **OK**, the list of appropriate subcategories is displayed.



3. Rotate  to select an item. Press .



▶▶ Place Category

The straight line distance (as the crow flies, not driving distance) and direction to the destination are shown for the highlighted place.

The following items are available:

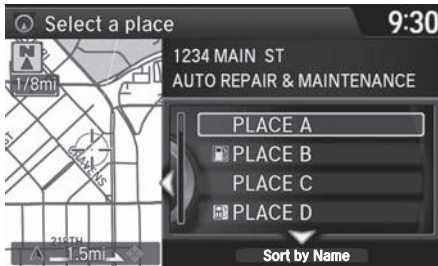
- **Search by Name:** Searches for a place in the subcategory by name. Enter a city name when prompted.
- **Sort by Distance to Travel:** Displays all the places in the subcategory sorted by distance from your current location. The closest place is displayed at the top.
- **City Vicinity:** Searches for a place in the subcategory within a 20 mile (32 km) radius of a specific city. Enter a city name and then a place name when prompted. Only the first 1000 matching places/landmarks are displayed.



4. Rotate  to select a place name from the list. Press .

5. Set the route to your destination.



▶ **Calculating the Route** P. 115

Local Search

 **MENU** button ▶ **Local Search**

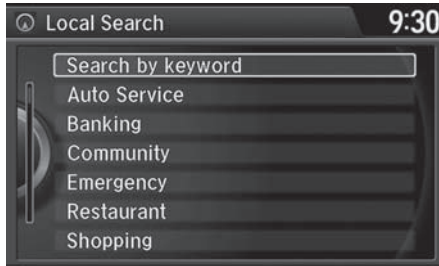
Select a place via Local Search database as the destination.



1. Rotate  to select a category (e.g., **Community**). Press .



2. Rotate  to select a subcategory. Press .



Local Search

When you select **Search by keyword**, the list of appropriate categories is displayed.

The screen in this section may differ from the actual ones.

Local Search is a subscription service. For more information, contact an Acura dealer or visit owners.acura.com (U.S.) or www.myacura.ca (Canada).



3. Rotate  to select an item. Press .
4. Set the route to your destination.
 **Calculating the Route** P. 115

The following items are available:



- **Search Nearby:** Finds the nearest POI around your vehicle.
- **Search from Map:** Selects a POI by scrolling the Interface Dial on the map screen.
- **Search from Destination:** Selects a POI around the destination. Search the category by scrolling the Interface Dial.

Place Name



 **MENU** button ▶ **Place Name**

Enter the name of a place (e.g., business, hotel, restaurant) stored in the map database to use as the destination.







1. Enter a place name.
2. Move  to select **OK** to display a list of matching hits. Press .



3. Rotate  to select a place name from the list. Press .
 - ▶ If the place name is in multiple categories, the categories are displayed when you select it.
 - **Place Name in Multiple Categories** P. 106
4. Set the route to your destination.
 - **Calculating the Route** P. 115

▶▶ Place Name

U.S. models

You can find a place by name using voice commands. Say  "Place Name" on the Voice Portal screen. Say a category, for example  "ATM/Bank." Say the name of the place, for example  "ABC Bank." The system interprets the name. Say  "Set as destination" to set the route.



This option is convenient if you know the exact name of a place.

Once a name is entered and selected, move  to select **Sort by Name** or **Sort by Distance**. Matching letters are highlighted.

■ Place Name in Multiple Categories

If the place name is in multiple categories in the map database, the following screen is displayed.



1. Rotate  to select a place name. Press .

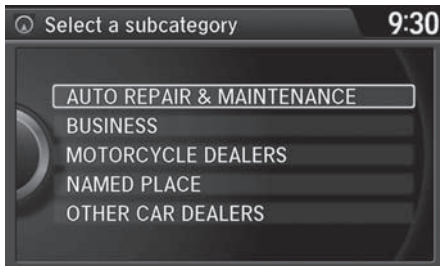



2. Rotate  to select a subcategory. Press .

▣ Place Name in Multiple Categories

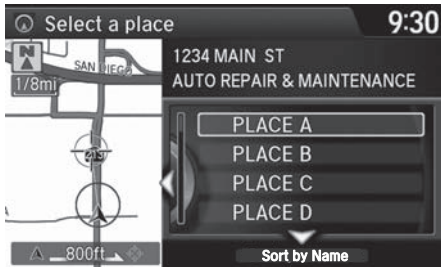
Matching letters are in highlighted.



3. Rotate  to select a place. Press .
4. Set the route to your destination.
 - ▶ **Calculating the Route** P. 115

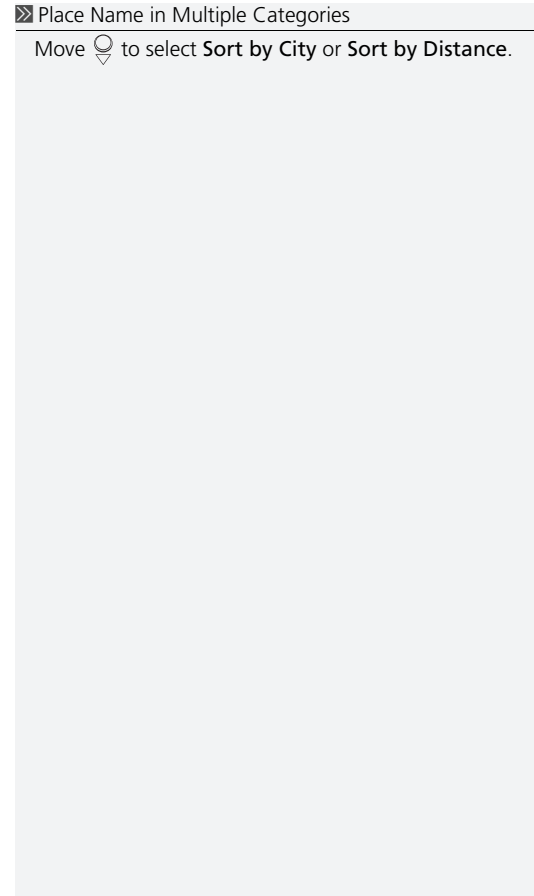



Place Phone Number

 **MENU** button ▶ **More Search Methods** ▶ **Place Phone Number**

Select a destination by phone number. Only phone numbers in the database are recognized.





1. Enter the area code and phone number.
2. Rotate  to select **OK**. Press .
3. Set the route to your destination.
 **Calculating the Route** P. 115

Place Phone Number

All 10 digits must be entered.

Phone numbers of private residences entered in your address book are not stored in the database and thus cannot be used to search for a destination.



A list is displayed if there are multiple locations in the database with the same phone number. Rotate  to select a place from the list. Press .

Download POI

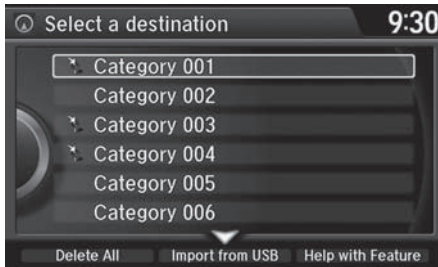

 **MENU** button ▶ **More Search Methods** ▶ **Download POI**

Select a place imported into the navigation system as the destination.



1. Rotate  to select a category from the list. Press .



2. Rotate  to select a place. Press .

3. Set the route to your destination.
 **Calculating the Route** P. 115

Download POI

Move  and rotate  to select the following items:

- **Import from USB:** Imports POI data into the navigation system.
 **Importing POI Categories** P. 50
- **Delete All:** Deletes all POI entries.
- **Help with Feature:** Views tips for the Download POI feature.

If you select **From AcuraLink**, you can download POI data stored on the AcuraLink® server.

Scenic Route

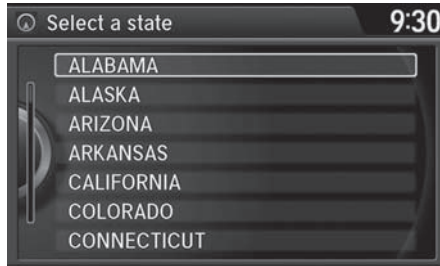

 **MENU** button ▶ **More Search Methods** ▶ **Scenic Route**

Select a scenic road as a destination (U.S. and Canada only).



1. Rotate  to select a state/province. Press .



2. Rotate  to select a scenic road. Press .

3. Set the route to your destination.

 **Calculating the Route** P. 115

Scenic Route



If you select a scenic road that runs through multiple states or provinces, only the portion of the road in the selected state or province is displayed.

Intersection

 **MENU** button ▶ **More Search Methods** ▶ **Intersection**

Select the intersection of two streets as the destination. The state or province for your current location is displayed at the top of the screen (e.g., California).



1. Rotate  to select the intersection search method. Press .
2. Set the route to your destination.
 - ▶ **Calculating the Route** P. 115

The following options are available:

- **City:** Selects the city where the intersection is located. You are prompted to enter the name of the two intersecting streets.
 - ▶ **Selecting a City** P. 95
- **Street:** Selects the two intersecting streets. The city or cities that the streets are located in are displayed.
 - ▶ **Selecting a Street** P. 96
- **Change State (U.S.)/Change Province (Canada):** Selects the state or province.
 - ▶ **Selecting the State or Province** P. 93

Intersection

It is usually easier to select **Street** to find the streets first. The city or cities that the streets are in will be displayed. If you select **City** and your city is not listed, it may be part of a larger metropolitan area. Try entering the street first.

If the intersection is outside the state or province you are currently in, rotate  to select **Change State/Change Province**.

▶ **Selecting the State or Province** P. 93

If there is more than one intersection, you are prompted to select the intersection. If the two streets that you have selected do not intersect, no intersection is entered.



Map Input

 **MENU** button ▶ **More Search Methods** ▶ **Map Input**

Use the Interface Dial to manually select an icon or a location on the map screen as the destination.

You are prompted to define the map area to display.





1. Rotate  to select an item. Press .

The following items are available:

- **Current Position:** Your current location is centered on the map.
- **State (U.S.)/Province (Canada):** You are prompted to select the state or province.
 - ▶ **Selecting the State or Province** P. 93
- **City:** You are prompted to select the city.
 - ▶ **Selecting a City** P. 95
- **USA, Canada and Mexico:** Your current location is displayed on a map of the country.



2. Scroll the map to position the cursor over your desired destination, adjusting the map scale as necessary.
 - ▶ If the address is not the desired location, scroll the map to another location and try again.
3. Press  to display the route calculation menu.
 - ▶ **Calculating the Route** P. 115
4. Rotate  to select **Set as Destination**. Press .

▶ Map Input

Auto Zoom

Press  repeatedly on the map to zoom in (to the scale 1/4 mile (400 m)) while scrolling the map.

Information icons are displayed at scales from 1 mile to 1/4 mile (1.6 km to 400 m). Place/landmark icons are displayed at 1/8 mile (200 m) or less. Roads are displayed at 1/4 mile (400 m) or less.

If you select multiple icons within the cursor radius, you are prompted to select one of the items from a list.

▶ **Selecting a Destination on the Map** P. 143

Coordinate

MENU button ▶ **More Search Methods** ▶ **Coordinate**

Specify a location using latitude and longitude map coordinates.



1. Enter the latitude and select **OK**.
2. Enter the longitude and select **OK**.



3. Move to scroll the map to position the cursor over your desired destination, adjusting the map scale as necessary.
 - ▶ If the address is not the desired location, scroll to another location and try again.
4. Press to display the route calculation menu.
 - ▶ **Calculating the Route** P. 115
5. Rotate to select **Set as Destination**. Press .



Coordinate

Latitude and longitude must be entered up to the seconds' value.

Calculating the Route

This section describes how to calculate your route.



1. Rotate  to select **Set as Destination**. Press .
 - ▶ The system calculates and displays the route line on the map screen.
 - **Route Line** P. 120
 - ▶ Move  to scroll the map around the destination.

The following options are available:

- **View Routes:** Displays three different routes.
 - **Viewing the Routes** P. 117
- **Route Preference:** Move  to select **Route Preference** to change the route preferences (calculating method).
 - **Route Preference** P. 54

Calculating the Route

The straight line distance (as the crow flies, not driving distance) and direction to the destination are shown.

You cannot use voice commands while the system is calculating the route.

Search Nearby

You can find the nearest place/landmark (e.g., nearest gas station) by specifying a category.

➤ **Find Nearest Place** P. 142

Call

You can place a telephone call to the destination phone number.

➤ **Bluetooth® HandsFreeLink®** P. 218

Save to Address Book

You can add the destination address to the address book.

➤ **Adding an Address Book Entry** P. 40

Edit/Delete Entry

You can edit or delete the address book entry.

➤ **Editing an Address Book Entry** P. 42



2. Follow the route guidance to your destination.

➤ **Driving to Your Destination**
P. 118

- ▶ The system provides you with pop-up messages if your route passes through unverified areas, avoid areas, or areas with traffic restrictions.

▶▶ Calculating the Route

Edit Home Entry

You can edit your home address entry.

➤ **Home Address** P. 46



More Info

You can view detailed information about the destination.

Viewing the Routes

View three different routes to your destination.



Rotate  to select a route. Press .

- ▶ The travel distance and estimated travel time is displayed for each route.
- ▶ The system calculates and displays the route line on the map screen.
 - **Route Line** P. 120

■ Using the Server Route



The following items are available:

- **Quick:** Displays the route with the shortest travel time.
- **Direct:** Displays the route with the shortest travel distance.
- **Eco:** Displays the route with the best fuel efficiency.

▶▶ Viewing the Routes

It is not unusual for some calculated route options to be identical.

Sever Routes is a subscription service. For more information, contact an Acura dealer or visit owners.acura.com (U.S.) or www.myacura.ca (Canada).

This section describes how to follow the route guidance to your destination, receive traffic information and choose the icons displayed on the map screen.

Viewing the Route

Map Screen



After calculating the route to your destination, the route is displayed on the map screen.

➔ **Map Screen Legend** P. 9

As you drive, the system tracks your position on the map in real time and provides guidance as you approach each guidance point on the route.

➔ **During Route Guidance** P. 10

Viewing the Route

➔ **"Display Map"**

You can change the map scale using voice commands (e.g., say **"Display 2 mile (3 km) scale"**).

➔ **Map Scale Commands** P. 314

You can also change the map scale by rotating .

You can control the icons displayed on the map screen using voice commands (e.g., say **"Display post office"**).

➔ **Map Display Commands** P. 314

You can obtain information about the route using voice commands (e.g., say **"How long to the destination?"**).

➔ **Route Commands** P. 316

You can display the next guidance point on the map screen by saying **"Display Map Guide"** (when en route).

If you scroll the map while en route, the time and distance to destination indicators are replaced with an indicator showing distance from the current vehicle position.

You can display only the map screen or a split map-guidance screen.

➔ **Guidance Mode** P. 63

Guidance Screen

The guidance screen offers an alternative way to view your route.

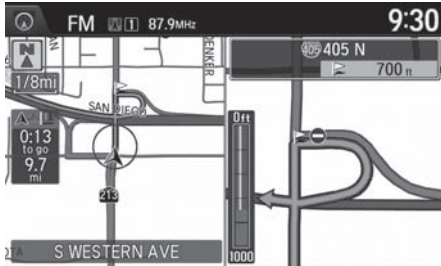

- ▶ The next guidance point is displayed as you approach each guidance point on the route.
- ▶ You can also view a list of guidance directions.

Guidance Screen

A visual guide helps you check the guidance screen.

➤ **Guidance Screen** P. 10

Turn-by-Turn Directions

The next guidance point appears on the multi-information display.

➤ **Turn-by-Turn Directions** P. 10

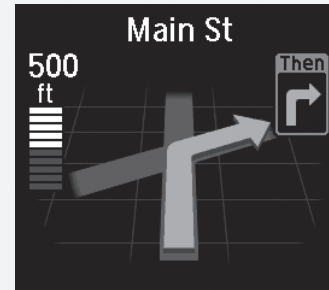

You can turn this feature on or off using the multi-information display. See the Owner's Manual for instructions.

Route Line

When driving on verified streets, the route line is light blue. The route line display changes when driving on unverified streets:

Straight line guide

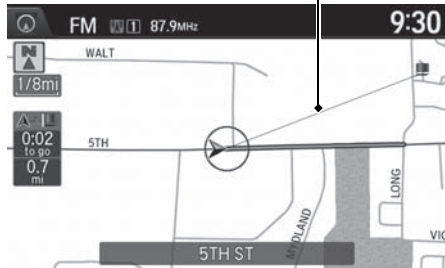

Blue-pink route line

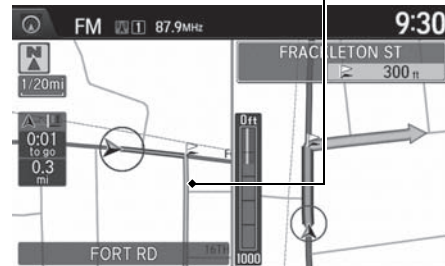

- If **Unverified Routing** is **Off**, the route line uses verified streets only (when possible). If **Straight Line Guide** is set to **On**, a pink “vector line” pointing directly towards your destination is displayed.
 - ▶ **Straight Line Guide** P. 78

- If **Unverified Routing** is **On**, the route line changes to a blue-pink line to indicate that the route line uses unverified streets.

Route Line

You can set **Unverified Routing** to **Off** to follow your own route to the destination. If **Unverified Routing** is **On**, be aware that unverified streets may not be displayed accurately.

▶ **Unverified Routing** P. 56

You can always view the entire route by simply saying  “Display entire route.”

The route line may also consist of red, orange, or green segments when traffic information is displayed.

▶ **AcuraLink Real-Time Traffic™** P. 14

▶ **Traffic Rerouting™** P. 130

■ Deviating From the Planned Route

If you leave the calculated route, the system automatically recalculates a route to the desired destination based on your current location and direction.

➤ **Route Preference** P. 54

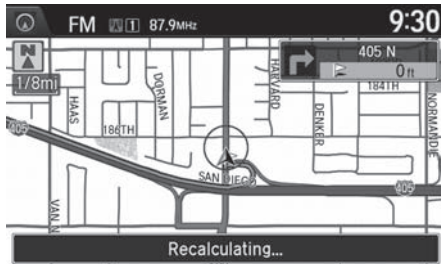

■ Tracking Dots

You can display a series of dots (breadcrumbs) to track the path you are taking. If needed, you can follow the dots back to the mapped road you originally left.

➔ **Display Tracking** P. 84



▣ Tracking Dots

A message “Not on a digitized road” may appear when you drive 1/2 mile (800 m) away from a mapped road.

Breadcrumbs may occasionally be displayed in urban areas, such as large parking lots in shopping malls, in new subdivisions where the roads are not yet in the database, or in areas where a GPS signal is unavailable, such as in a parking garage.

Breadcrumbs are limited to approximately 150 miles (240 km). Breadcrumbs at the beginning of the trail are deleted if you exceed that distance.

Breadcrumbs are displayed only at 1/20, 1/8, 1/4, and 1/2 mile (80, 200, 400, and 800 m) map scales.

Listening to Voice Guidance

 **ENTER** button (on map) ▶ **Voice**

As you approach each guidance point, a pop-up window is displayed on the map screen with instructions for you to follow. Voice guidance for each guidance point is also provided.

Typically, you hear three prompts:

- 1/2 mile (800 m) from the guidance point (2 miles (3 km) on freeway/highway)
- 1/4 mile (400 m) from the guidance point (1 mile (1.5 km) on freeway/highway)
- Just before the guidance point

To replay voice guidance, rotate  to select **Voice** in the Map Menu.

If you select **Voice** between guidance points, voice guidance for the next guidance point is provided.

Listening to Voice Guidance

 "Voice" (on the map screen)

You can turn voice guidance OFF if you prefer. Press the **SETTINGS** button. Select **System Settings** and set **Guidance Volume** to **0**.

You can also adjust **Guidance Volume** by rotating the volume knob while the route guidance or voice command confirmations is announced.

When driving in unverified areas, the phrase "if possible" is inserted before each voice guidance prompt.

Voice in the Map Menu may be grayed out if:



- The system is in process of gathering the route guidance information.
- The vehicle is out of the road (e.g., pulling in a parking lot).

The timing of voice guidance varies depending on the type of road you are on and the distance to the next guidance point.

Reaching a Waypoint

When you reach a waypoint, a pop-up message is displayed. You can continue or pause the route guidance.



Rotate  to select **No** to pause the route guidance. Press .

▶ Select **Yes** to continue the guidance.

Resuming the route guidance

You can resume the route guidance in the following ways:



- Restart the engine when you stop your car (e.g., to rest, stop for gas, etc.).
 - ▶ **Resuming Your Trip** P. 145
- Select **Resume Guidance** from the navigation menu or the map menu.
 - ▶ **Map Menu** P. 125
 - ▶ **Changing Your Route** P. 133

Displaying the Map Menu

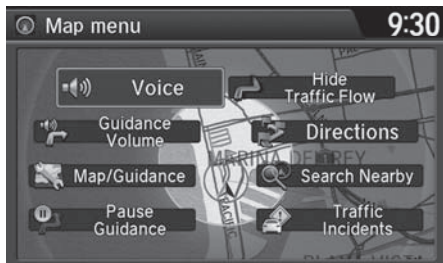
Use the Map Menu to control the icons displayed on the screen and to display traffic information and messages. You can also use the Map Menu to find locations or to cancel the route.



1. On the map screen, press .
▶ The Map Menu is displayed on the map screen.

2. Rotate  to select an item. Press .

Map Menu

If you scroll the map while en route, press the **NAV** (or **BACK**) button to return to the current position map screen, then press .

Traffic Incidents

You must have an AcuraLink Real-Time Traffic™ subscription to receive traffic information.

➤ **AcuraLink®** P. 266

The incident icons are displayed on the 5 mile (8 km) or less map scale.

➤ **Map Scale and Functions** P. 81

The following items are available:

- **Voice:** Select to hear the voice guidance when en route.
 - **Listening to Voice Guidance** P. 123
- **Guidance Volume:** Adjusts the navigation system volume level.
- **Map/Guidance:** Allows you to select the map and guidance settings (display mode, icons to display on the map, map orientation, map color, and 3D view angle), display your current location and an overview of the map features.
 - **Guidance Mode** P. 63
 - **Showing Icons on Map** P. 71
 - **Color** P. 73
 - **View (Map Orientation)** P. 76
 - **3D Angle Adjustment** P. 77
 - **Current Location** P. 79
 - **Map Legend** P. 80
- **Pause Guidance:** Pauses your current route.
 - **Pausing the Route** P. 134
- **Resume Guidance:** Resumes your current route. This item is displayed while the route guidance is paused.
- **Hide Traffic Flow:** Hides the current traffic flow indicator on the map screen.
 - **Hide Traffic Flow** P. 127
- **Display Traffic Flow:** Displays the current traffic flow indicator on the map screen. This item is displayed while the current traffic flow indicator is hided.
- **Directions:** Displays a list of the guidance points.
 - **Directions** P. 128
- **Search Nearby:** Allows you to find the nearest place/landmark (e.g., nearest gas station) by specifying a category. You can then add the location to the list of destinations, set as a waypoint, or set as your destination.
 - **Find Nearest Place** P. 142

Map Menu

Directions

The system provides freeway/highway exit information only in the U.S.

- **Traffic Incidents:** Displays a list of the traffic incidents around your current location or on your current route.
 - ▶ **Traffic Rerouting™** P. 130

Hide Traffic Flow

 **ENTER** button (on map) ▶ **Hide Traffic Flow**

Hide the traffic flow indicator on the map screen. Press the **ENTER** button and select **Display Traffic Flow** to display the traffic flow indicator on the map screen.

Directions

📍 ENTER button (on map) ▶ Directions

Display a list of the guidance points on your route for your confirmation.

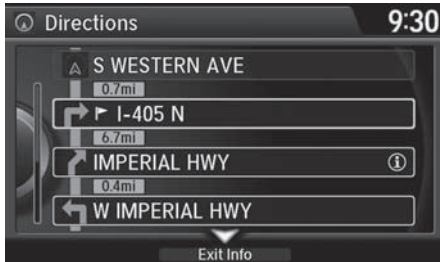

1. Rotate 🔄 to select a guidance point from the list. Press ⏪.
▶ The system displays a map of the guidance point.

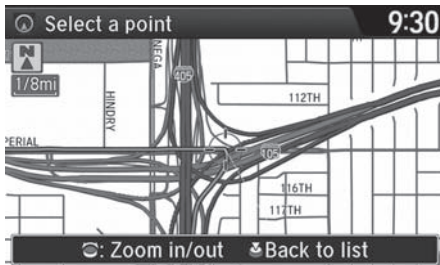

2. Press ⏪ to select **Back to list** or press the **BACK** button to return to the previous screen.

📄 Directions

Guidance points with exit information are indicated by a **i** (freeway/highway exit information) icon. Move 📍 to select **Exit Info** to display the exit information.

➡ **Freeway/highway Exit Information** P. 129

The system provides freeway/highway exit information only in the U.S.

The route guidance information is automatically deleted when you reach your destination.

Freeway/highway Exit Information

📍 **ENTER** button (on map) ▶ **Directions** ▶ **Exit Info**

Display a list of the Freeway/highway exits for the route. You can view freeway/highway exit information (whether the exit is near gas stations, restaurants, ATMs, etc.) and add new destinations or waypoints to the calculated route.



1. Rotate 🔄 to select an exit from the list. Press 📍.



2. Rotate 🔄 to select a list item. Press 📍.

- ▶ Move ◀○ or ○▶ to display information for different exits.
- ▶ You can set the route to your destination.

➤ **Calculating the Route** P. 115

Freeway/highway Exit Information

📍 "Display Freeway (highway) Exit Information"

You can scroll the map and select a ⓘ (Freeway/highway exit information) icon on the map screen to display the Freeway/highway exit information. The ⓘ icon is only displayed if there is exit information available.

Icons are displayed only at 1/4, 1/2, or 1 mile (400 m, 800 m, or 1.6 km) scale.

➤ **Map Scale and Functions** P. 81

The system provides freeway/highway exit information only in the U.S.

The route guidance information is automatically deleted when you reach your destination.

Traffic Rerouting™

When driving to your destination, the system automatically searches for a faster route based on traffic flow information and traffic incidents.

▶ **AcuraLink Real-Time Traffic™** P. 14

▶ **Traffic Rerouting** P. 58



▶▶ Traffic Rerouting™

This feature requires an AcuraLink Real-Time Traffic™ subscription.

AcuraLink Real-Time Traffic™ is a subscription service. For more information, contact an Acura dealer or visit owners.acura.com (U.S.) or www.myacura.ca (Canada).



Automatic traffic rerouting may not provide a detour route depending on circumstances.

Traffic Rerouting™ Manually



 **ENTER** button (on map) ▶ **Traffic Incidents**

Manually avoid specific incidents and/or congestion on your route:



1. Rotate  to select an incident from the list. Press .

▶ The system displays the map screen and the incident location.

2. Rotate  to select **Avoid**. Press .

▶ Repeat step 1 to 2 as necessary.

Traffic Rerouting™ Manually

 "Display traffic",  "Display traffic incidents"

You can display traffic incidents using voice commands.

➔ **Map Display Commands** P. 314

You can choose to avoid up to 10 traffic incidents. It is not always possible for the system to calculate a route that avoids all traffic incidents or specific traffic incidents you select.



The "On Route" tab on the Traffic List screen is only available during route guidance.

You cannot select an incident to avoid from the "All" tab.

You can also manually detour around a traffic incident or unexpected delay even if you do not have an AcuraLink Real-Time Traffic™ subscription or the delay does not yet appear on your display.

➔ **Taking a Detour** P. 141





3. Move  to select **Recalculate Route**. Press .
- The system recalculates a detour route that avoids the traffic incidents.

Changing Your Route

 **MENU** button (when en route)

This section describes how to alter your route, add an interim “waypoint” (pit stop), choose a different destination, cancel your current destination, and continue your trip after stopping.



Rotate  to select an item. Press .

The following items are available:

- **Voice:** Select to hear the voice guidance when en route.
 - **Listening to Voice Guidance** P. 123
- **Destination List:** Shows a list of waypoints. You can delete waypoints or edit the order of them.
 - **Editing the Destination List** P. 139
- **Pause Guidance:** Pauses your current route.
 - **Pausing the Route** P. 134
- **Resume Guidance:** Resumes your current route. This item is displayed while the route guidance is paused.
- **Cancel Route:** Cancels the route guidance.
 - **Canceling the Route** P. 134
- **View Routes:** Displays three different routes.
 - **Viewing the Routes** P. 117

Changing Your Route

 “Display Navigation” (when en route)

If you press the **MENU** button when not en route, the Destination Menu screen is displayed.

➤ **Entering a Destination** P. 90

- **Change Route Preference:** Changes the route preferences (calculating method).
 - ▣ **Route Preference** P. 54
- **Detour:** Calculates a detour route.
 - ▣ **Taking a Detour** P. 141
- **Avoid Streets:** Avoids streets along your route.
 - ▣ **Avoiding Streets** P. 141

Pausing the Route

🗄 **MENU** button (when en route) ► **Pause Guidance**

Pause the route guidance and return to the map screen. The destination icons and all waypoint flags remain displayed on the map. Press the **MENU** button when en route and select **Resume Guidance** to resume the route guidance.

Canceling the Route

🗄 **MENU** button (when en route) ► **Cancel Route**

Cancel the route guidance and remove the destination and all waypoints from the destination list. The system then returns to the map screen.

▣ Pausing the Route

You can also pause your route from the Map Menu.

▣ **Map Menu** P. 125

Adding Waypoints

Add up to four waypoints (pit stops) along the route to your destination.

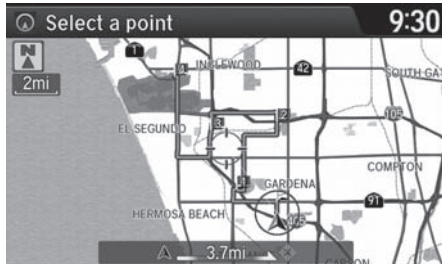

Waypoints are displayed on the map screen as small, numbered red flags. The route follows the waypoints in the order they are listed in the Destination List.

✕ Adding Waypoints

Waypoints allow you to stop for gas or food, for example, and then continue on to your destination.

Press the **NAV** button to return to the map screen without adding a waypoint at any time.

The search corridor used for adding waypoints can be adjusted.

➤ **Edit POI Search Radius Along Route** P. 59

You can delete waypoints or edit the order of waypoints in the destination list.

➤ **Editing the Destination List** P. 139

■ Adding Waypoints from the Route Menu

📍 MENU button (when en route) ▶ Destination List ▶ Add New Destination
▶ Find Along Route

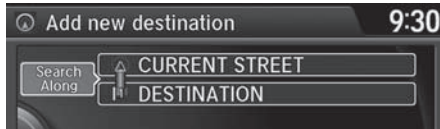

The following items are available:

- **Search Around:** Searches in a spiral pattern around the location you select.
- **Search Along:** Searches within a "corridor" on either side of the locations you select.

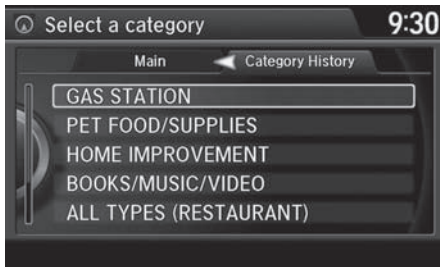

1. Rotate 🔄 to select a search method to add a waypoint. Press 📍.



2. Rotate 🔄 to select a waypoint category (e.g., GAS STATION). Press 📍.

▶▶ Adding Waypoints from the Route Menu

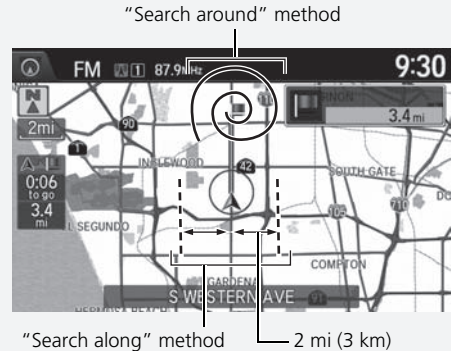

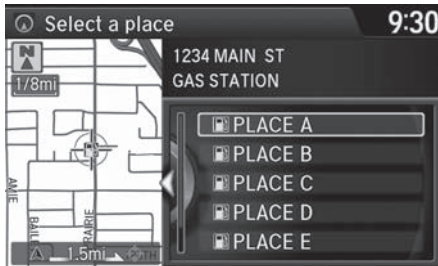
Search method





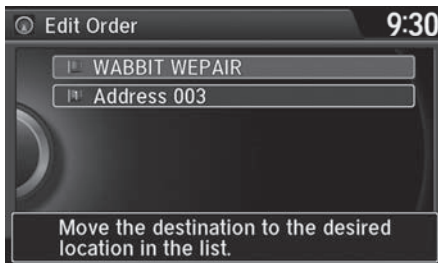



3. Rotate  to select a place. Press .
 - ▶ The waypoint is added to the Destination List.

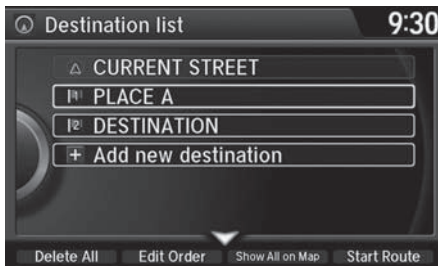

4. Rotate  to select a location and move the order of destinations. Press .



5. Move  and rotate  to select **Start Route**. Press .
 - ▶ The route is automatically recalculated and displayed on the map screen.

■ Adding Waypoints from the Navigation Menu

📍 MENU button (when en route) ► Destination List ► Add New Destination

▣ Adding Waypoints from the Navigation Menu



You can edit the order of waypoints and destination.
➤ **Editing the Destination List** P. 139



1. Rotate  to select a method to enter a waypoint.

- ▣ **Entering a Destination** P. 90
- A new destination is added to the end of the Destination list.



2. Move  and rotate  to select **Start Route**. Press .

- The route is automatically recalculated and displayed on the map screen.

Editing the Destination List

■ Editing the Order of Waypoints

MENU button (when en route) ► **Destination List**

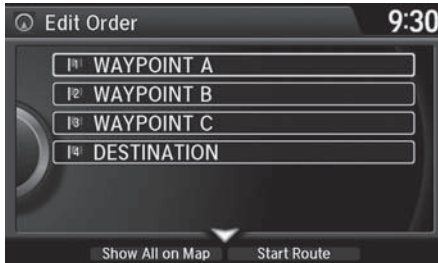

1. Move and rotate to select **Edit Order**. Press .

2. Rotate to select a list item to move. Press .

3. Rotate to select a new location. Press .

4. Move and rotate to select **Start Route**. Press .

► The route is automatically recalculated and displayed on the map screen.



▣ Editing the Order of Waypoints

Move to rotate to select **Show All on Map** to display the destination and waypoints on the map screen.



■ Deleting Waypoints



 **MENU** button (when en route) ► **Destination List**

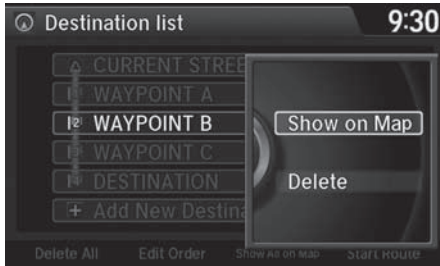



1. Rotate  to select a list item to delete. Press .



2. Rotate  to select **Delete**. Press .

3. Rotate  to select **Yes**. Press .

▣ Deleting Waypoints

Move  and rotate  to select **Delete All** to delete the destination and all the waypoints.

Select **Show on Map** to display the waypoint on the map screen.

Taking a Detour

 **MENU** button (when en route) ▶ **Detour**



Calculate a detour route manually. The system attempts to calculate a new route by avoiding the next 5 miles (8 km) (while on a freeway/highway) or 1 mile (1.6 km) (while on a surface street).

Avoiding Streets

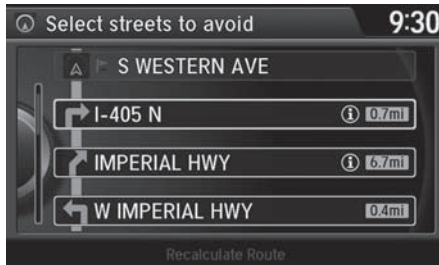

 **MENU** button (when en route) ▶ **Avoid Streets**

Select a street or streets along your route to avoid.

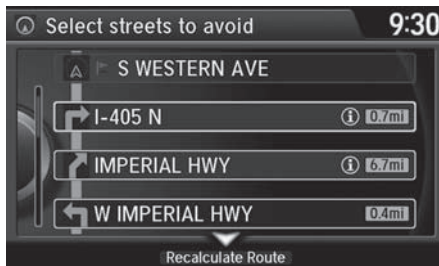

1. Rotate  to select the street you want to avoid. Press .
▶ Repeat the procedure to avoid other streets.



2. Move  to select **Recalculate Route**. Press .
▶ The system calculates a new route.

▶ Taking a Detour

The detour option is convenient if you encounter an unexpected obstacle such as a road closure or extremely heavy traffic congestion.

▶ Avoiding Streets

Avoiding certain streets is convenient if you know of road construction, road closures, or excessive traffic along the route.

You cannot choose specific streets you want to use, only those to avoid. However, you can select intersections or waypoints (places/landmarks) that the system will use in your route.

 **Adding Waypoints** P. 135

You can store up to 10 streets to avoid. You cannot avoid your current street or the streets of your waypoint(s) or destination (system beeps if selected).









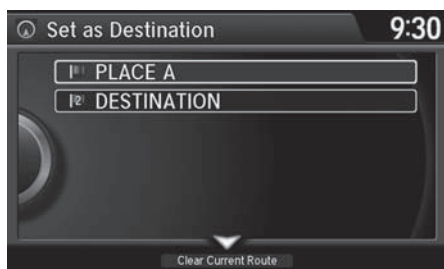



There are several methods you can use to change the route destination.

Find Nearest Place

 **ENTER** button (on map) ► **Search Nearby**

Search for the nearest place/landmark on the map screen and set it as your destination.



1. Rotate  to select **Search Nearby**. Press .
2. Rotate  to select a category type. Press .
3. Rotate  to select a place. Press .
4. Rotate  to select **Set as Destination**. Press .
5. Move  to select **Clear Current Route**. Press 
 - The route is automatically recalculated and displayed on the map screen.
 - Rotate  to edit the order to set the location as a new waypoint. Press .

Find Nearest Place

 "Find Nearest..."

The Find Nearest voice command is the fastest method of specifying a place/landmark as your destination. Many kinds of places can be found.

► **Find Place Commands** P. 315

Selecting a Destination on the Map

Select a new destination when en route by selecting a location on the map.



1. Scroll the map to position the cursor over your desired destination, adjusting the map scale as necessary. Press .
 - ▶ If the address displayed is not the desired location, press the **BACK** button and repeat the procedure.
2. Rotate to select **Set as Destination**. Press .
 - ▶ **Calculating the Route** P. 115

3. Move to select **Clear Current Route**. Press .
 - ▶ The route is automatically recalculated and displayed on the map screen.
 - ▶ Rotate to edit the order to set the location as a new waypoint. Press .

Selecting a Destination on the Map

If there is more than one icon or street under the map cursor, you are prompted to select the item from a list.

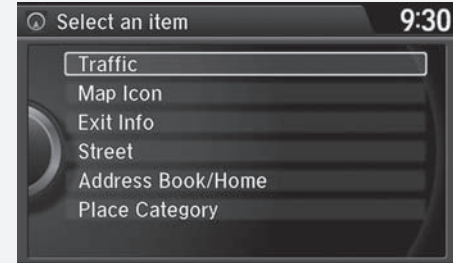



Rotate to select an item. Press .

Entering a New Destination

 **MENU** button (when en route) ► **Destination**

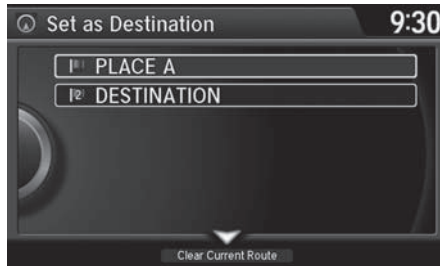

Enter a new destination using the Destination Menu screen even when you are en route.



1. Rotate  to select a method to enter a new destination.



►  **Entering a Destination** P. 90

► After entering a new destination, the address is displayed on the Calculate Route screen.



2. Rotate  to select **Set as Destination**. Press .

3. Move  to select **Clear Current Route**. Press .

► The route is automatically recalculated and displayed on the map screen.

► Rotate  to edit the order to set the location as a new waypoint. Press .



►► Entering a New Destination

 "Display Destination",  "Display Navigation"

Stop your vehicle en route (e.g., to rest, stop for gas, etc.), and then continue on your route.

If you did not complete your route, the Continue Trip screen is displayed when you restart your vehicle.



Rotate  to select **Set as Destination**. Press .

- ▶ You can continue on the same route.
- ▶ Move  to scroll the map around the destination.
- ▶ Press the **BACK** button to cancel your destination.

- **Route Preference:** Move  to select **Route Preference** to change the route preferences (calculating method).
 - **Route Preference** P. 54
- **View Routes:** Displays three different routes.
 - **Viewing the Routes** P. 117

Resuming Your Trip

The Continue Trip screen has the same options as when you calculate a route.

➤ **Calculating the Route** P. 115

You can also cancel your destination by pressing any hard button except the  button.

Search Nearby

You can find the nearest place/landmark (e.g., nearest gas station) by specifying a category.

➤ **Find Nearest Place** P. 142

Call

You can place a telephone call to the destination phone number.

➤ **Bluetooth® HandsFreeLink®** P. 218

Save to Address Book

You can add the destination address to the address book.

➤ **Adding an Address Book Entry** P. 40

Edit/Delete Entry

You can edit or delete the address book entry.

➤ **Editing an Address Book Entry** P. 42

Edit Home Entry

You can edit your home address entry.

➤ **Home Address** P. 46

More Info

You can view detailed information about the destination.

Audio

This section describes how to operate the audio system. You can play music from a wide array of media sources, and control the audio system using the audio buttons, the Interface Dial, or voice control.



Audio System	148	Audio Menu	167	Playing Internet Radio	202
About Your Audio System	148	SiriusXM® Radio Service	169	Selecting Internet Radio Mode	202
USB Port	149	Playing a Disc	171	Pandora® Menu	203
Auxiliary Input Jack	150	Selecting Disc Mode	171	Aha™ Radio Menu	205
Audio System Theft Protection	150	Audio Screen Control	172	Playing a USB Flash Drive	207
Setting Audio Shortcuts	151	Audio Menu	173	Selecting USB Mode	208
Customizing Audio Source	152	Recommended CDs	176	Audio Screen Control	209
Audio Remote Controls	153	Playing Hard Disc Drive (HDD) Audio	178	Audio Menu	210
Steering Wheel Controls	153	Selecting HDD Mode	178	Playing Bluetooth® Audio	213
Audio Settings	155	Recording a Music CD to HDD	179	Selecting Bluetooth® Audio Mode	213
Adjusting the Sound	156	Audio Screen Control	180	Audio Screen Control	214
Playing FM/AM Radio	158	Audio Menu	181		
Selecting FM/AM Mode	158	Playing an iPod	190		
Audio Screen Control	159	Selecting iPod Mode	191		
Audio Menu	161	Audio Screen Control	192		
Playing SiriusXM® Radio	164	Audio Menu	194		
Selecting SiriusXM® Mode	164	Song By Voice™ (SBV)	197		
Audio Screen Control	165				

About Your Audio System

The audio system features AM/FM radio and the SiriusXM® Radio service. It can also play audio CDs, WMA/MP3/AAC files, Hard Disc Drive (HDD) audio, USB flash drives, iPod, iPhone and *Bluetooth*® devices.

You can operate the audio system from the buttons and switches on the panel, the icons on the touchscreen interface.

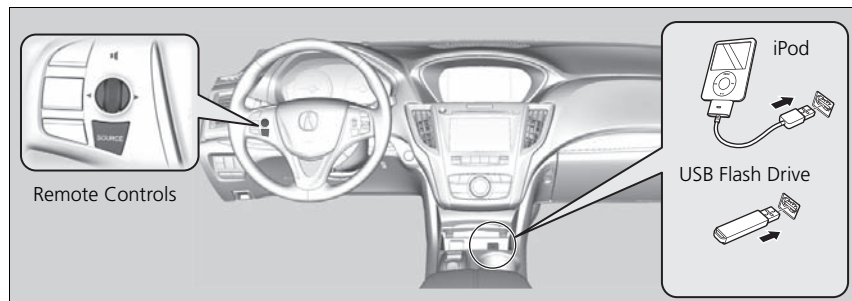

▣ About Your Audio System

SiriusXM® Radio is available on a subscription basis only. For more information on SiriusXM® Radio, contact a dealer.

▣ **SiriusXM® Radio Service** P. 169

SiriusXM® Radio is available in the U.S. and Canada, except Hawaii, Alaska, and Puerto Rico.

SiriusXM® is a registered trademark of Sirius XM® Radio, Inc.

Video CDs, DVDs, and 3 in (80 mm) mini CDs are not supported.

iPod, iPhone and iTunes are trademarks of Apple Inc.

State or local laws may prohibit the operation of handheld electronic devices while operating a vehicle.

When the screen is viewed through polarized sunglasses, a rainbow pattern may appear on the screen due to optical characteristics of the screen. If this is disturbing, please operate the screen without polarized sunglasses.

USB Port

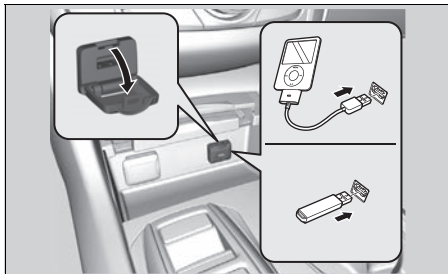

Install the iPod or iPhone dock connector or the USB flash drive to the USB port.

⊗ USB Port

- Do not leave the iPod or USB flash drive in the vehicle. Direct sunlight and high temperatures may damage it.
- Do not connect the iPod or USB flash drive using a hub.
- Do not use a device such as a card reader or hard disc drive, as the device or your files may be damaged.
- We recommend backing up your data before using the device in your vehicle.
- Displayed messages may vary depending on the device model and software version.

If the audio system does not recognize the iPod, try reconnecting it a few times or reboot the device. To reboot, follow the manufacturer's instructions provided with the iPod or visit www.apple.com/ipod.

Auxiliary Input Jack

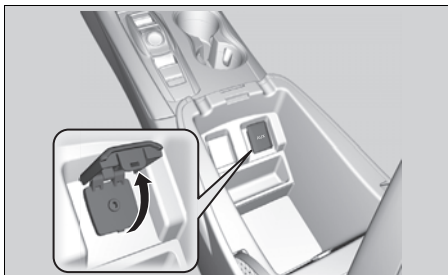

Use the jack to connect standard audio devices.

1. Open the center console.
2. Open the AUX cover.
3. Connect a standard audio device to the input jack using a 1/8 in (3.5 mm) stereo miniplug.
 - ▶ The audio system automatically switches to the AUX mode.

Audio System Theft Protection

The audio system is disabled when it is disconnected from the power source, such as when the battery is disconnected or goes dead. In certain conditions, the system may display Enter code. If this occurs, reactivate the audio system.

■ Reactivate the audio system

1. Set the power mode to ON.
2. Turn on the audio system.
3. Press and hold the audio system power button for more than two seconds.
 - ▶ The audio system is reactivated when the audio control unit establishes a connection with the vehicle control unit. If the control unit fails to recognize the audio unit, you must go to a dealer and have the audio unit checked.

▶ Auxiliary Input Jack

You can return to the AUX mode by selecting **Change Source** on the Audio menu screen or **Audio Source** on the On Demand Multi-Use Display™.

Setting Audio Shortcuts

You can store up to six radio stations, and HDD audio album/play lists when playing AM, FM, SiriusXM® radio, or HDD audio.

▶▶ Setting Audio Shortcuts

You can also preset a station or song by pressing and holding the preset icon you want to store that station or song after step 3.

■ Storing a station or song



1. Select **Shortcuts**.
2. Tune to a radio station or select a song.
 - ▶ **Playing FM/AM Radio** P. 158
 - ▶ **Playing SiriusXM® Radio** P. 164
 - ▶ **Playing Hard Disc Drive (HDD) Audio** P. 178
3. Select **Audio**.
4. Select **Edit** or **No Entry**.
 - ▶ If you select **No Entry**, go to step 6.
5. Select **Add**.
6. Select the preset icon you want to store the station or song to.



Continued

■ Deleting a preset station or song

1. Select **Shortcuts**.
2. Select **Audio**.
3. Select **Edit**.
4. Select **Delete**.
5. Select the preset icon with the radio station or a song you want to delete.

Customizing Audio Source

You can customize order of the source list icons.



1. Select **Audio Source**.
2. Select **Edit Order**.
3. Select two icons you want to swap.
4. Select **Done**.
 - ▶ Select **Default** to reset the customized order.

▣ Customizing Audio Source

This operation is not allowed while the vehicle is in motion.

Steering Wheel Controls

Control basic audio system functions using the controls mounted on the steering wheel.

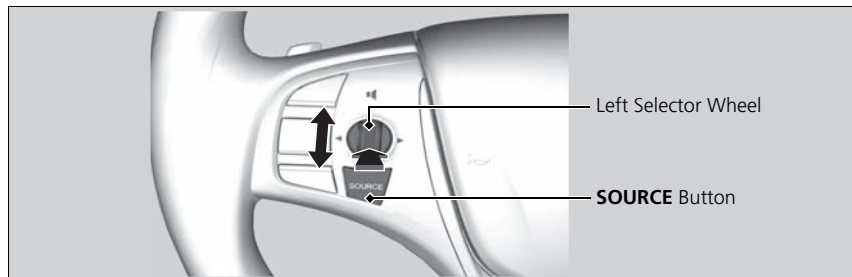

SOURCE Button

Cycles through the audio modes as follows:

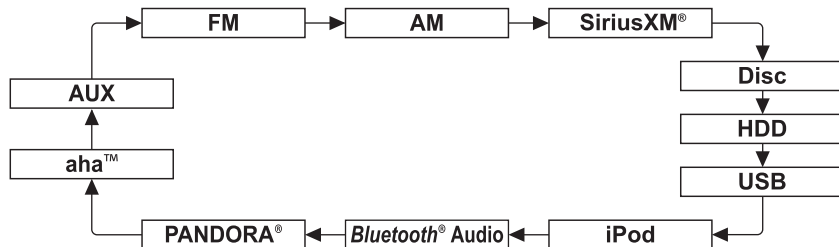

Audio Remote Controls

The CD mode appears only when a CD is loaded.

The USB mode, iPod mode, *Bluetooth*® Audio mode, Pandora®* mode, and Aha™ mode appear when a connection (*Bluetooth*® or USB) is established with a device.

To select audio mode, press the **SOURCE** button, then move the left selector wheel to the right or left.

*: Pandora® is available on U.S. models only.

■ Left Selector Wheel

Roll Up to increase the volume.

Roll Down to decrease the volume.

Push to mute. Push again to unmute.

FM/AM, SiriusXM®

- Move to the right to select the next preset radio station.
- Move to the left to select the previous preset radio station.
- Move to the right and hold to scan to the next strong station.
- Move to the left and hold to scan to the previous strong station.

CD, HDD, iPod, USB flash drive, or *Bluetooth*® Audio

- Move to the right to skip to the next song.
- Move to the left to go back to the beginning of the current or previous song.
- Move to the right and hold to go to the group up. (*Bluetooth*® Audio only)
- Move to the left and hold to go to the group down. (*Bluetooth*® Audio only)

CD, HDD or USB flash drive

- Move to the right and hold to skip to the next folder.
- Move to the left and hold to go back to the previous folder.

Pandora®* or Aha™



- Move to the right to skip to the next song.
- Move to the right and hold to select the next station.
- Move to the left and hold to select the previous station.

☒ Left Selector Wheel

*: Pandora® is available on U.S. models only.

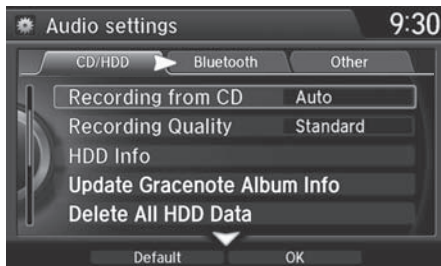
SETTINGS button ► Audio Settings



1. Move ◀○ or ○▶ to select an audio mode you want to set.
2. Rotate  to select an item. Press .

The following items are available:

- **Source Select Popup:** Selects whether the list of selectable audio sources comes on when the **AUDIO** button is pressed.
- **HD Radio Mode*** (AM/FM mode): Selects whether the audio system automatically switches to the digital radio waves or receives the analogue waves only.
- **Cover Art** (CD (MP3/WMA/AAC), iPod, USB, Pandora®* or Aha™ mode): Turns on and off the cover art display.
- **Bluetooth Device List:** Displays the *Bluetooth*® device list.
- **Connect Bluetooth Audio Device** (*Bluetooth*® Audio, Pandora®* or Aha™ mode): Connects, disconnects or pairs a *Bluetooth*® Audio device to HFL.
- **Recording from CD** (CD mode): Selects whether the songs on music CDs are automatically recorded to the HDD.
- **Recording Quality** (CD mode): Selects the quality of the music files recorded to the HDD.
- **HDD Info** (HDD mode): Displays the HDD capacity.

Audio Settings

*: This function is available on U.S. models only.

- **Update Gracenote Album Info** (CD or HDD mode): Updates the Gracenote® Album Info (Gracenote® Media Database) from CD or from USB.
 - ❏ **Updating Gracenote® Album Info** P. 188
- **Delete All HDD Data** (HDD mode): Resets all the menu and customized settings, and delete all music data on the HDD.
- **Default**: Cancels/Resets all customized items in the Audio Settings group as default.

Adjusting the Sound

🔊 **MENU** button ▶ **Sound**

Interface Dial

Adjust the sound bass, treble, fader, and balance. You can also adjust the strength of the sound coming from the center and subwoofer speakers. In addition, you can set Speed-sensitive Volume Compensation (SVC) and DTS Neural Surround.

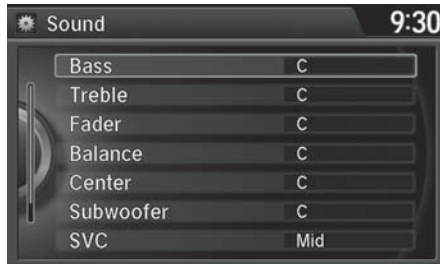

1. Rotate 🔄 to select the sound mode to adjust. Press ⏸.
2. Rotate 🔄 to adjust the desired level. Press ⏸.

▶▶ Adjusting the Sound

The SVC has four modes: **Off**, **Low**, **Mid**, and **High**.

SVC adjusts the volume level based on the vehicle speed. As you go faster, audio volume increases. As you slow down, audio volume decreases.

DTS Neural Surround is a trademark of DTS, Inc.

When available, DTS Neural Surround converts stereo sound into surround sound.

On Demand Multi-Use Display™



1. Select **More**.
2. Select **Sound**.
3. Use **+**, **-** or other icon to adjust the setting.
 - ▶ Use the **▲/▼** icons to turn the page.
 - ▶ Select **X** to go back to the previous screen.

▶ Adjusting the Sound





Select **Off**, **Low**, **Mid** or **High** for the SVC setting.

▶ **Adjusting the Sound** P. 156

You can also adjust the sound to select **🎵** on the On Demand Multi-Use Display™.

Selecting FM/AM Mode

Interface Dial

1. Press the **MENU** button. (in AUDIO mode)
2. Rotate  to select **Change Source**. Press .
3. Rotate  to select the frequency band (FM, AM). Press .
 - ▶ The band and frequency are displayed on the navigation screen.

On Demand Multi-Use Display™

1. Select **Audio Source**.
2. Select the frequency band (FM, AM) icon.
 - ▶ The band and frequency are displayed on the On Demand Multi-Use Display™.

▶ Selecting FM/AM Mode

 "Display audio"

You can control the AM/FM radio using voice commands.

▶ **Radio commands** P. 318

The **ST** indicator appears on the display indicating stereo FM broadcasts.

Stereo reproduction in AM is not available.

The radio can receive the complete AM and FM bands:

AM band: 530 to 1710 kHz

FM band: 87.7 to 107.9 MHz



You can store 6 AM stations and 12 FM stations into the preset memory.

Audio Screen Control

Control the audio system through the navigation screen and On Demand Multi-Use Display™.

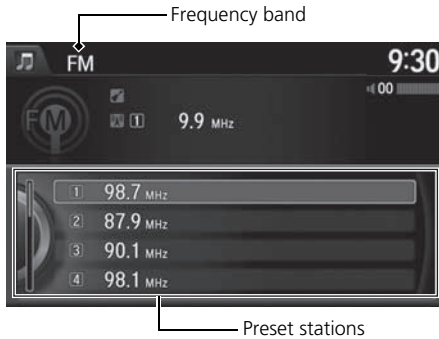
Interface Dial



Rotate  to select a preset station.
Press .

- ▶ Press and hold  for a few seconds to store the current station.
- ▶ Press **MENU** button to display the menu items.

▶ **Audio Menu P. 161**

On Demand Multi-Use Display™

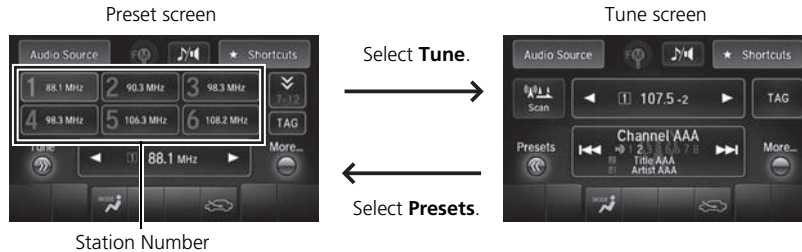

The following items are available:

- ◀ ▶: Tune the radio frequency. Select and hold to search that station on preset screen.
- ⏪ ⏩: Search up and down the selected band for a station with a strong signal.
- More: Display the menu items.
 - ▶ **Audio Menu** P. 161
- Scan: Scans for stations with a strong signal in the current band and plays a 10-second sample. Select **Stop Scan** to stop scanning and play the current selection.

■ Preset Memory

To store a station:

1. Tune to the selected station on preset screen.
2. Select and hold a desired number you want to store the station.

To listen to a stored station, select the station number.

▶▶ Audio Screen Control

U.S. models



Select **TAG** to tag the song if it is played on an HD Radio™ station. The iPod/iPhone should be connected to the audio system to store the tagged song information on your device.

Audio Menu



 **MENU** button (in FM/AM mode)

Interface Dial



Rotate  to select an item. Press .

The following items are available:

- **Sound:** Adjusts the settings of the audio speaker's sound.
 - ▶ **Adjusting the Sound** P. 156
- **Station List:** Displays the stored station list.
- **Scan:** Scans for stations with a strong signal in the current band and plays a 10-second sample. Select **Stop Scan** to stop scanning and play the current selection.
- **Radio Text:** Displays the text information broadcast by the current RDS station.
- **Save Preset:** Stores the station into the preset memory.
- **Change Source:** Changes the audio source mode.
- **Tune/Seek:** Tunes the radio to the frequency you select. Rotate  to select a frequency, then Move .

- **Tag Song***: Displays the TAG information saved to the audio system when an HD Radio™ station is selected.
- **Tagged Song List***: You can store the TAG information in the connected iPod/iPhone. If the iPod/iPhone is not connected to the audio system, the information is stored in the audio unit temporarily, then once the device is connected to the system, data is transferred to the iPod/iPhone.
- **HD Subchannel***: Displays the subchannel list when an HD Radio™ station is selected.

On Demand Multi-Use Display™



1. Select **More**.
2. Select a setting item.

The following items are available:

- **Sound**: Displays the sound preferences screen.
 - ▶ **Adjusting the Sound** P. 156
- **Save Preset**: Stores the station into the preset memory.
- **Screen Settings**: Adjusts the screen's preferences.
 - ▶ **Changing the Screen Settings** P. 88
- **Scan**: Scans for stations with a strong signal in the current band and plays a 10-second sample. Select **Stop Scan** to stop scanning and play the current selection.
- **HD Subchannel***: Displays the subchannel list when an HD Radio™ station is selected.

▶ Audio Menu

U.S. models

iTunes Tagging*

"iTunes" in "iTunes Tagging" is a trademark of Apple Inc.

When an HD Radio™ station is selected, the **HD** indicator appears on the Navigation screen and On Demand Multi-Use Display™.

If you want to have the information on the song played from the HD Radio™ station, select **TAG** in On Demand Multi-Use Display™ or select **Tag Song** in the menu with Interface dial.

If iPod/iPhone is connected, the tag is transferred to the connected device immediately, otherwise the tag will be transferred when the device will be connected and select **Tag Song** in the menu with Interface dial.

*: This function is available on U.S. models only.



HD Radio Technology manufactured under license from iBiquity Digital Corporation. U.S. and Foreign Patents. HD Radio™ and the HD, HD Radio and "Arc" logos are proprietary trademarks of iBiquity digital Corp.



Radio Data System

 **MENU** button (in FM mode) ▶ **Station List**

Provides text data information related to your selected RDS-capable FM station.

■ To find an RDS station from Station List





Rotate  to select the station. Press .

■ Manual update







Updates your available station list at any time.

Rotate  to select **Refresh**. Press .

Selecting SiriusXM® Mode

Interface Dial

1. Press the **MENU** button. (in AUDIO mode)
2. Rotate  to select **Change Source**. Press .
3. Rotate  to select **XM**. Press .
 - ▶ The band and channel are displayed on the navigation screen.

On Demand Multi-Use Display™

1. Select **Audio Source**.
2. Select the XM icon.
 - ▶ The band and channel are displayed on the On Demand Multi-Use display™.

▶▶ Playing SiriusXM® Radio

You can control the SiriusXM® radio using voice commands.

▶ Voice Control Operation P. 6

In the channel mode, all available channels are selectable. In the category mode, you can select a channel within a category (Jazz, Rock, Classical, etc.).

There may be instances when SiriusXM® Radio does not broadcast all the data fields (artist name, title). This does not indicate a problem with your audio system.

You can store 12 SiriusXM® stations into the preset memory.



SiriusXM® Radio station load in ascending order, which can take about a minute. Once they have loaded, you can scroll up or down to make your selections.

Audio Screen Control

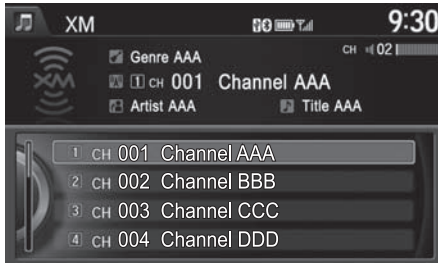
Control the audio system through the navigation screen and On Demand Multi-Use Display™.



Interface Dial

Rotate  to select a preset channel.
Press .

- ▶ Press and hold  for a few seconds to store the current channel.
- ▶ Press **MENU** button to display the menu items.

➤ **Audio Menu P. 167**

On Demand Multi-Use Display™

Preset screen



Station Number

Select **Tune**.



Tune screen



Select **Presets**.



The following items are available:

- : Select to display and select an SiriusXM® Radio category. Select and hold to search that station on preset screen.
- : Select to the previous or next channel. Select and hold to change the channel rapidly.
- **More**: Display the menu items.
 - **Audio Menu** P. 167
- **Scan**: Scans for stations with a strong signal in the current band and plays a 10-second sample. Select **Stop Scan** to stop scanning and play the current selection.

■ **Preset Memory**

To store a station:

1. Tune to the selected station on preset screen.
2. Select and hold a desired number you want to store the station.



To listen to a stored station, select the station number.

Audio Menu

 **MENU** button (in SiriusXM® mode)

Interface Dial



Rotate  to select an item. Press .

The following items are available:

- **Sound:** Adjusts the settings of the audio speaker's sound.
 - ▶ **Adjusting the Sound** P. 156
- **Scan:** Scans for channels in the selected mode and plays a 10- second sample. Select **Stop Scan** to stop scanning and play the current selection.
- **Change Source:** Changes the audio source mode.
- **Save Preset:** Stores the station into the preset memory.
- **XM Tune Mode:**
 - Channel Mode:** Scans to select all available channels.
 - Category Mode:** Scans to select a channel within a category (Jazz, Rock, Classic, etc.).

On Demand Multi-Use Display™



1. Select **More**.
2. Select a setting item.

The following items are available:

- **Sound:** Displays the sound preferences screen.
 - ▶ **Adjusting the Sound** P. 156
- **Save Preset:** Stores the station into the preset memory.
- **Screen Settings:** Adjusts the screen's preferences.
 - ▶ **Changing the Screen Settings** P. 88
- **Scan:** Scans for channels with a strong signal in the selected mode and plays a 10- second sample. Select **Stop Scan** to stop scanning and play the current selection.
- **XM Tune Mode:** Sets the scan mode.
 - Channel:** Scans to select all available channels.
 - Category:** Scans to select a channel within a category (Jazz, Rock, Classic, etc.).

SiriusXM® Radio Service

■ Subscribing to SiriusXM® Radio

1. You need your radio ID ready before registering for subscription. To see the ID in the display: Operate the On Demand Multi-Use Display™ until channel 0 appears.
2. Have your radio ID and credit card number ready, and either call or visit the SiriusXM® website to subscribe.

■ Receiving SiriusXM® Radio

Switch to the SiriusXM® mode by pressing the **SOURCE** button repeatedly or operating the On Demand Multi-Use Display™, and stay in this mode for about 30 minutes until the service is activated. Make sure your vehicle is in an open area with good reception.

☒ Subscribing to SiriusXM® Radio

Contact Information for SiriusXM® Radio:
 U.S.: SiriusXM® Radio at www.siriusxm.com or (800) 852-9696
 Canada: SiriusXM® Canada at www.xmradio.ca, or (877) 209-0079

☒ Receiving SiriusXM® Radio

The SiriusXM® satellites are in orbit over the equator; therefore, objects south of the vehicle may cause satellite reception interruptions. Satellite signals are more likely to be blocked by tall buildings and mountains the farther north you travel from the equator.

You may experience reception problems under the following circumstances:

- In a location with an obstruction to the south of your vehicle
- In tunnels
- On the lower level of a multi-tiered road
- Large items carried on the roof rack

■ SiriusXM® Radio Display Messages

Loading:

SiriusXM® is loading the audio or program information.

Ch off air:

The channel is not currently broadcasting.

Ch unauthorized:

SiriusXM® radio is receiving information update from the network.

No signal:

The signal is too weak in the current location.

Ch unavailable:

No such channel exists, the channel is not part of your subscription, or the artist or title information is unavailable.





Check antenna:

There is a problem with the SiriusXM® antenna. Contact a dealer.

Your audio system supports audio CDs, CD-Rs and CD-RWs in either MP3, WMA, or AAC format. With the CD loaded, select the CD mode.

Selecting Disc Mode

Interface Dial

1. Insert a disc into the disc slot.
 - ▶ The disc automatically being playing.
2. Press the **MENU** button. (in AUDIO mode)
3. Rotate  to select **Change Source**. Press .
4. Rotate  to select **CD**. Press .

On Demand Multi-Use Display™

1. Insert a disc into the disc slot.
 - ▶ The disc automatically being playing.
2. Select **Audio Source**.
3. Select the CD icon.

▶▶ Playing a Disc

NOTICE

Do not use CDs with adhesive labels. The label can cause the CD to jam in the unit.

WMA and ACC files protected by digital rights management (DRM) cannot be played. The audio system displays Unplayable File, then skips to the next file.

Text data appears on the display under the following circumstances:

- When you select a new folder, file, or track.
- When you change the audio mode to CD.
- When you insert a CD.

If you eject the CD but do not remove it from the slot, the system reloads the CD automatically after several seconds.

You can control a CD audio using voice commands.

▶▶ **Disc commands** P. 319

Audio Screen Control

Control the audio system through the navigation screen and On Demand Multi-Use Display™.

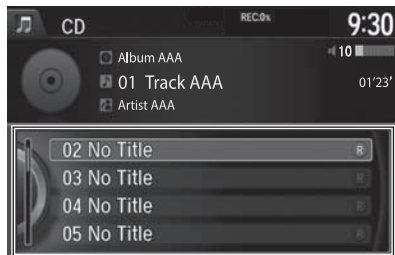

Track list



Interface Dial

1. Rotate or Press to display the song list.
2. Rotate , move or to select a file from the list. Press .
 - ▶ Press **MENU** button to display the menu items.
 - ▶ **Audio Menu** P. 173

On Demand Multi-Use Display™

1. Select to skip to the next folder, and to skip to the beginning of the previous folder in MP3, WMA, or AAC.
2. Select or to change tracks (files in MP3, WMA, or AAC). Select and hold to move rapidly within a track/file.
 - ▶ Select **More** to display the menu item.
 - ▶ **Audio Menu** P. 173

▶▶ Audio Screen Control

On Demand Multi-Use Display™



- **Random:** Plays all tracks/files in random order.
- **Repeat:** Repeats the current track/file.
- **Scan:** Provides 10-second sampling of all tracks on the CD (all files in the current folder in MP3, WMA, or AAC). Select **Stop Scan** to stop scanning and play the current selection.

Audio Menu

 **MENU** button (in CD mode)

Interface Dial



Rotate  select an item. Press .

The following items are available, depending on the type of disc:

- **Sound:** Adjusts the settings of the audio speaker's sound.
 - ▶ **Adjusting the Sound** P. 156
- **Scan:**
 - Scan Folders** (MP3/WMA/AAC): Provides 10-second sampling of the first file in each of the main folders.
 - Scan Tracks:** Provides 10-second sampling of all tracks on the CD (all files in the current folder in MP3, WMA, or AAC).
- **Music Search:** Selects a file from the Music Search list.
 - ▶ **How to Select a File from the Music Search List (MP3/WMA/AAC)** P. 175
- **Change Source:** Changes the audio source mode.
- **Random/Repeat:**
 - Repeat Folder** (MP3/WMA/AAC): Repeats all files in the current folder.
 - Repeat Track:** Repeats the current track/file.
 - Random in Folder** (MP3/WMA/AAC): Plays all files in the current folder in random order.
 - Random All Tracks:** Plays all tracks/files in random order.

Continued

- **Rec to HDD:** Records a music CD onto the HDD for playback using HDD Audio.
▶ **Recording a Music CD to HDD** P. 179

On Demand Multi-Use Display™

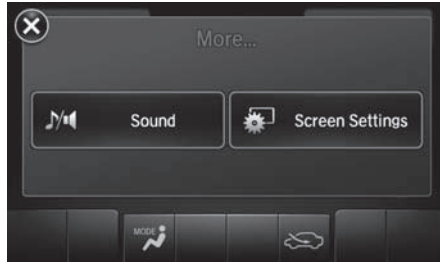

1. Select **More**.
2. Select a setting item.





The following items are available, depending on the type of disc:

- **Sound:** Displays the sound preferences screen.
▶ **Adjusting the Sound** P. 156
- **Screen Settings:** Displays the screen preferences screen.
▶ **Changing the Screen Settings** P. 88

How to Select a File from the Music Search List (MP3/WMA/AAC)

 **MENU** button (in CD mode) ▶ **Music Search**



Rotate , move  or  to select a file from the Music Search list. Press .

Recommended CDs

- Use only high-quality CD-R or CD-RW discs labeled for audio use.
- Use only CD-R or CD-RW discs on which the recordings are closed.
- Play only standard round-shaped CDs.

The CD packages or jackets should have one of these marks.



Also includes:



CDs with MP3, WMA or AAC files

- Some software files may not allow for audio play or text data display.
- Some versions of MP3, WMA or AAC formats may be unsupported.

Recommended CDs

A Dual-disc cannot play on this audio unit. If recorded under certain conditions, a CD-R or CD-RW may not play either.

For DTS patents, see <http://patents.dts.com>. Manufactured under license from DTS Licensing Limited. DTS, the Symbol, & DTS and the Symbol together are registered trademarks, and DTS Neural Surround is a trademark of DTS, Inc. © DTS, Inc. All Rights Reserved.

■ Protecting CDs

Follow these precautions when handling or storing CDs:

- Store a CD in its case when it is not being played.
- When wiping a CD, use a soft clean cloth from the center to the outside edge.
- Handle a CD by its edge. Never touch either surface.
- Never insert foreign objects into the CD player.
- Keep CDs out of direct sunlight and extreme heat.
- Do not place stabilizer rings or labels on the CD.
- Avoid fingerprints, liquids, and felt-tip pens on the CD.

▶▶ Protecting CDs

NOTICE

Do not insert a damaged CD. It may be stuck inside and damage the audio unit.

Examples:

Bubbled, wrinkled, labeled, and excessively thick CDs

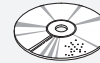

Bubbled/
Wrinkled

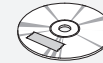

With Label/
Sticker



Using Printer
Label Kit

Damaged CDs



Sealed

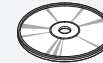

With Plastic Ring

Poor quality CDs

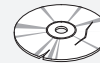

Chipped/
Cracked

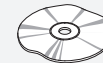

Warped

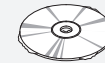

Burrs

Small CDs







3 in (80 mm) CD

The Hard Disc Drive (HDD) Audio function plays tracks from music CDs that have been recorded onto the built-in HDD. You can arrange the tracks in playlists or play the tracks using various search methods.

Selecting HDD Mode

Interface Dial

1. Press the **MENU** button. (in AUDIO mode)
2. Rotate  to select **Change Source**. Press .
3. Rotate  to select **HDD**. Press  to play tracks stored on the HDD.
 - ▶ Title information is displayed if found in the Gracenote® Album Info (Gracenote® Media Database) stored on the HDD.
 - ▶ The HDD has two types of playlists: original playlists and user playlists. An original playlist is automatically created for each album when a music CD is recorded. You can customize up to six user playlists provided on the HDD by adding tracks from your original playlists.

On Demand Multi-Use Display™

1. Select **Audio Source**.
2. Select the HDD icon to play tracks stored on the HDD.

▶▶ Playing Hard Disc Drive (HDD) Audio

You can control the HDD audio using voice commands.

- ▶ **HDD commands** P. 318
- ▶ **Song By Voice™ (SBV)** P. 197

Music tracks recorded on HDD cannot be recorded onto CDs or other devices.

Tracks are recorded at four times the playback speed using ultra-efficient compression technology; therefore, sound quality may vary slightly from the original.

If the HDD is ever replaced, all music data is lost and cannot be recovered.

If there is a problem, you may see an error message on the display.

- ▶ **Hard Disc Drive (HDD) Audio** P. 292

Recording a Music CD to HDD

The songs on music CDs are automatically recorded by factory default to the HDD the first time you play each disc. You can then play the songs directly from the HDD.

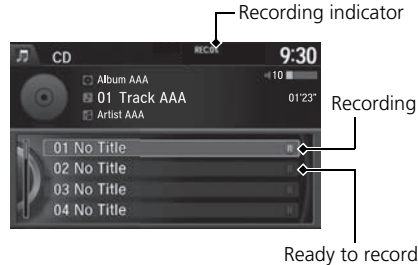

Stopping Recording

1. Press the **MENU** button. (in CD mode)
2. Rotate to select **Cancel Record to HDD**. Press .

Recording a CD Manually

1. Press the **MENU** button. (in CD mode)
2. Rotate to select **Rec to HDD**. Press .

Recording a Music CD to HDD

You can add tracks to user playlists, where you can mix and match tracks from other CDs recorded on the HDD.

- ▶ **Editing an Album or Playlist** P. 184
- ▶ **Editing Track Information** P. 186

If you stop the engine or the power system is turned off while recording a CD, there may be pauses between songs when you play back from the HDD.

Repeat, random, and scan functions are not available during recording.

You can play music from other sources (e.g., SiriusXM®, HDD, etc.) while recording.

Please note that there is no compensation offered in the case of unsuccessful recording of audio data or the loss of audio data due to any cause whatsoever.

Clearing the HDD

Any music tracks stored on the HDD can be deleted.

Audio Screen Control

Control the audio system through the navigation screen and On Demand Multi-Use Display™.

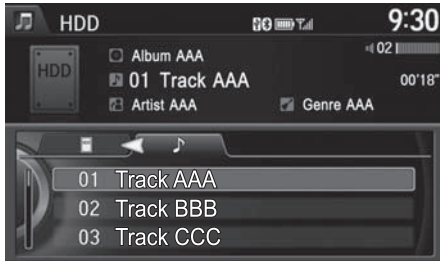

Interface Dial

1. Rotate or press to display the song list.
2. Rotate , move or to select a track from the list. Press .
 - ▶ Press **MENU** button to display the menu items.

▶ **Audio Menu** P. 181

On Demand Multi-Use Display™

1. Select skip to the next playlist/album, and to skip to the beginning of the previous playlist/album.
2. Select or to change tracks.
 - Select and hold to move rapidly within a track.
 - ▶ Select **More** to display the menu item.

▶ **Audio Menu** P. 181

▶▶ Audio Screen Control

▶▶ On Demand Multi-Use Display™



- **Repeat:**
 - Repeat Artist:** Repeats all tracks in the current artist.
 - Repeat Album:** Repeats all tracks in the current album.
 - Repeat Track:** Repeats the current track.
- **Random:**
 - Random in Artist:** Plays all tracks in the current artist in random order.
 - Random in Album:** Plays all tracks in the current album in random order.
 - Random All Tracks:** Plays all tracks in random order.
- **Scan:**
 - Albums:** Provides 10-second sampling of the first track in each album.
 - Tracks:** Provides 10-second sampling of all tracks on HDD.

Audio Menu

 **MENU** button (in HDD mode)

Interface Dial



Rotate  to select an item. Press .

The following items are available:

- **Sound:** Adjusts the settings of the audio speaker's sound.
 - ▶ **Adjusting the Sound** P. 156
- **Scan:**
 - Scan Albums:** Provides 10-second sampling of the first track in each album.
 - Scan Tracks:** Provides 10-second sampling of all tracks on HDD.
- **Music Search:** Selects a file from the Music Search list.
 - ▶ **How to Select a Track from the Music Search List** P. 183
- **Change Source:** Changes the audio source mode.
- **Random/Repeat:** The following menu items vary depending on the category you selected by the Music Search list.
 - Repeat Artist:** Repeats all tracks in the current artist.
 - Repeat Album:** Repeats all tracks in the current album.
 - Repeat Track:** Repeats the current track.
 - Random in Artist:** Plays all tracks in the current artist in random order.
 - Random in Album:** Plays all tracks in the current album in random order.
 - Random All Tracks:** Plays all tracks in random order.

Continued

- **Edit/Delete:** Change the playlist name, album name, genre, and track order of the current playlist. You can also delete tracks, playlists, and albums.

On Demand Multi-Use Display™

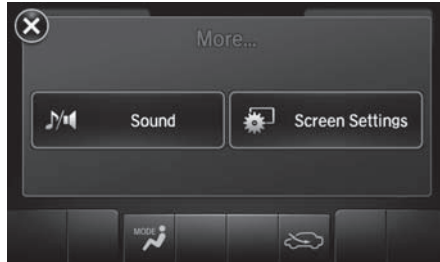

1. Select **More**.
2. Select a setting item.

The following items are available:

- **Sound:** Displays the sound preferences screen.
 - ▶ **Adjusting the Sound** P. 156
- **Screen Settings:** Displays the screen preferences screen.
 - ▶ **Changing the Screen Settings** P. 88



■ How to Select a Track from the Music Search List

 **MENU** button (in HDD mode) ▶ **Music Search**

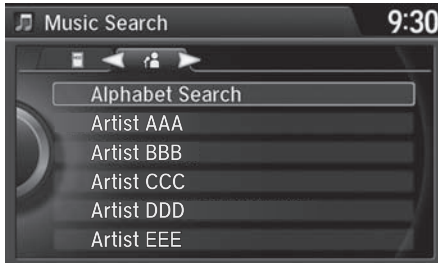

1. Move ◀○ or ○▶ to select a search category. Press .







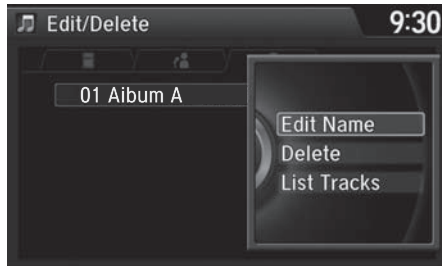

2. Rotate  to select a track from the Music Search list. Press .

■ Editing an Album or Playlist

 **MENU** button (in HDD mode) ▶ **Edit/Delete**



1. Rotate  to select **Albums** or **Playlist**. Press .
2. Rotate  to select an album or playlist that you want edit or delete. Press .
 - ▶ The pop-up menu appears on the screen.
3. Rotate  to select an item. Press .

The following items are available:

- **Edit Name:** Enter a new name using the interface dial or the On Demand Multi-Use Display™.
- **Delete:** Deletes the selected album or playlist.
- **List Tracks:** Change the track title, artist name, genre and composer. You can also delete tracks.

▣ Editing an Album or Playlist

The maximum number of original playlists is 50 with a maximum of 99 songs in each playlist.

Each album CD counts as an original playlist. Adding a track from a user playlist into the same user playlist will cause the track to appear twice in the playlist.

Deleting an album (original playlist) also deletes the album tracks you have stored in any user playlists.

Deleting a user playlist or deleting all tracks from a user playlist does not remove the playlist folder. The folder retains the playlist name and artist information.

■ Creating a new Playlist

🔑 **MENU** button (in HDD mode) ▶ **Edit/Delete** ▶ **Playlists** ▶ **Create New Playlist**



1. Enter the playlist name using the interface dial or the On Demand Multi-Use Display™.
2. Select tracks from the music search list.

■ Editing Track Information

🔑 **MENU** button (in HDD mode) ▶ **Edit/Delete** ▶ **Tracks**

Change the track title, artist name, genre and composer. You can also delete tracks.

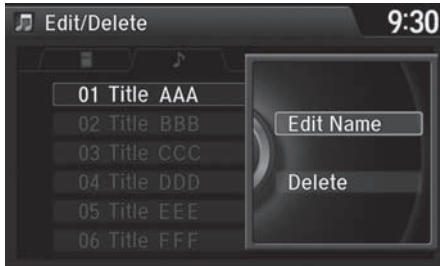

Rotate 🌀 select a track you want to edit or delete. Press 🕒.

▶ The pop-up menu appears on the screen.

The following items are available:

- **Edit Name:** Enter the track information (track name, track artist, etc.) using the interface dial or the On Demand Multi-Use Display™.
- **Delete:** Deletes a track.

■ Displaying Music Information

🔊 **MENU** button (in HDD mode) ▶ **Edit/Delete**

Music information (album name, artist name, genre) can be acquired by accessing the Gracenote® Album Info.

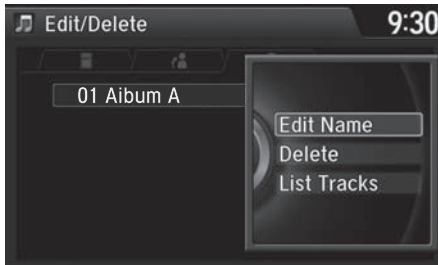





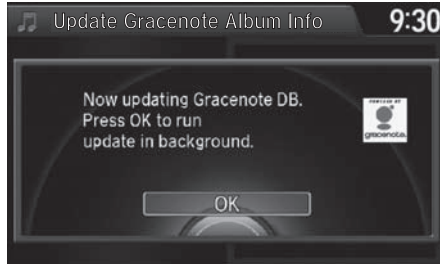

1. Rotate 🔄 to select **Albums**.
Press 🗑️.
2. Rotate 🔄 to select an album that you want edit or delete. Press 🗑️.
▶ The pop-up menu appears on the screen.
3. Rotate 🔄 to select **Edit Name**.
Press 🗑️.
4. Move ⬆️ to select **Get Music Info**.
Press 🗑️.
▶ The system starts to access the Gracenote® Album Info.

■ Updating Gracenote® Album Info

🔗 **SETTINGS** button (in HDD mode) ▶ **Audio Settings** ▶ **CD/HDD**

Update the Gracenote® Album Info (Gracenote® Media Database) that is included with the navigation system.



1. Insert the update disc into the disc slot or connect the USB flash drive that includes the update.
2. Rotate  to select **Update Gracenote Album Info**. Press .
3. Rotate  to select **Update by CD** or **Update by USB**. Press .
 - ▶ The system starts updating and the confirmation message appears on the screen. Press  to finish.

▣ Updating Gracenote® Album Info

To acquire updated files:

- Consult a dealer.
- Visit <http://www.navteq.com/gracenote/acura>.

Once you perform an update, any information you edited before will be overwritten or erased.

■ Deleting All HDD Data

📍 **SETTINGS** button ▶ **Audio Settings** ▶ **CD/HDD** ▶ **Delete All HDD Data**

Delete all music data on the HDD.



Rotate 📶 to select Yes. Press 📶.

■ Connecting an iPod

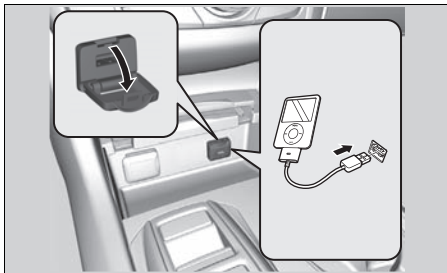

1. Open the USB cover.
2. Install the iPod dock connector to the USB connector.

■ Model Compatibility

Model

iPod (5th generation)

iPod classic 80GB/160GB (launch in 2007)

iPod classic 120GB (launch in 2008)

iPod classic 160GB (launch in 2009)

iPod nano (1st to 7th generation) launch in 2012

iPod touch (1st to 5th generation) launch in 2012

iPhone 3G/iPhone 3GS/iPhone 4/iPhone 4s/iPhone 5/iPhone 5s/iPhone 5c

⌘ Connecting an iPod

- Do not connect your iPod using a hub.
- Do not use a device such as a card reader or hard disc drive, as the device or your tracks may be damaged.
- We recommend backing up your data before using the device in your vehicle.
- Displayed messages may vary depending on the device model and software version.





Your audio system may not work with all software versions of these devices.

If the audio system does not recognize your iPod, try reconnecting it a few times or reboot the device.

State or local laws may prohibit the operation of handheld electronic devices while operating a vehicle.

Selecting iPod Mode

Interface Dial

1. Connect the iPod to the USB adapter cable in the console compartment.
2. Press the **MENU** button. (in AUDIO mode)
3. Rotate , select **Change Source**. Press .
4. Rotate , select **iPod**. Press .

On Demand Multi-Use Display™

1. Connect the iPod to the USB adapter cable in the console compartment.
2. Select **Audio Source**.
3. Select the iPod icon.

▶▶ Selecting iPod Mode

You can control an iPod using voice commands.

- ▶ **iPod commands** P. 319
- ▶ **Song By Voice™ (SBV)** P. 197

Available operating functions vary on models or versions. Some functions may not be available on the vehicle's audio system.

If there is a problem, you may see an error message on the navigation screen.

- ▶ **iPod/USB Flash Drive** P. 293





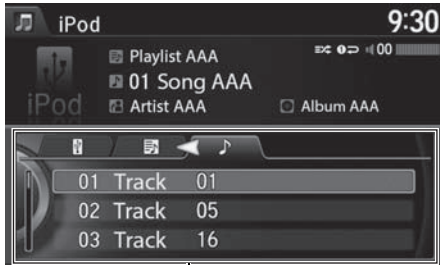

Audio Screen Control

Control the audio system through the navigation screen and On Demand Multi-Use Display™.



Track list

Interface Dial

1. Rotate  or Press  display the song list.
2. Rotate , move  or  to select a song from the list. Press .
 - ▶ Press **MENU** button to display the menu items.
 - ▶ **Audio Menu P. 194**

▶▶ Audio Screen Control

This function may not be available depending on models or versions.

Select  to go back to the previous screen.

On Demand Multi-Use Display™

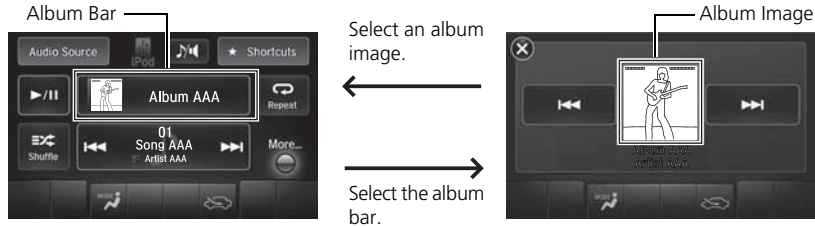

The following items are available:



- (play/pause): Plays or pauses a song file.
- : Select the previous or next track. Select and hold to move rapidly within a track.
- **Album bar**: Select to display the album search screen.
Select or to search for an album.
- **More**: Select to display the menu item.
 Audio Menu P. 194
- **Repeat**: Repeats the current track.
- **Shuffle**:
Shuffle Albums: Plays all available albums in a selected list (playlists, artists, albums, songs, genres, or composers) in random order.
Shuffle All Songs: Plays all available files in a selected list (playlists, artists, albums, songs, genres, or composers) in random order.

Audio Menu

 **MENU** button (in iPod mode)

Interface Dial



Rotate  to select an item. Press .

The following items are available:

- **Sound:** Adjusts the settings of the audio speaker's sound.
 - ▶ **Adjusting the Sound** P. 156
- **Music Search:** Selects a song from the Music Search list.
 - ▶ **How to Select a Song from the Music Search List** P. 196
- **Change Source:** Changes the audio source mode.
- **Play/Pause:** Pauses or plays a song file.
- **Shuffle/Repeat:**
 - Repeat Song:** Repeats the current track.
 - Shuffle Albums:** Plays all available albums in a selected list (playlists, artists, albums, songs, genres, or composers) in random order.
 - Shuffle All Songs:** Plays all available files in a selected list (playlists, artists, albums, songs, genres, or composers) in random order.

On Demand Multi-Use Display™

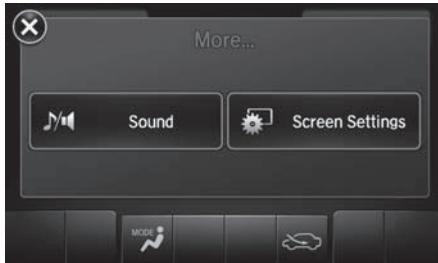

1. Select **More**.
2. Select a setting item.

The following items are available:

- **Sound**: Displays the sound preferences screen.
 - **Adjusting the Sound** P. 156
- **Screen Settings**: Displays the screen preferences screen.
 - **Changing the Screen Settings** P. 88



■ How to Select a Song from the Music Search List

 **MENU** button (in iPod mode) ▶ **Music Search**



1. Move  or  to select a search category. Press .



2. Rotate  to select a file from the Music Search list. Press .

Song By Voice™ (SBV)

Use SBV to search for and play music from your HDD or iPod using voice commands.

■ Settings Song By Voice™ (SBV)

 **SETTINGS** button ▶ **System Settings** ▶ **Song By Voice**





Rotate  to select **On** or **Off**. Press .

The following items are available:

- **On** (factory default): Song By Voice commands are available.
- **Off**: Disable the feature.

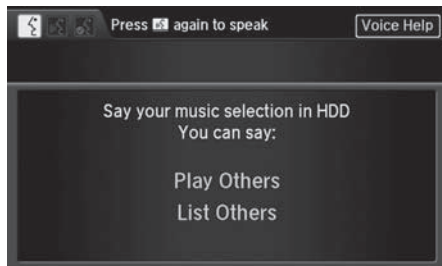
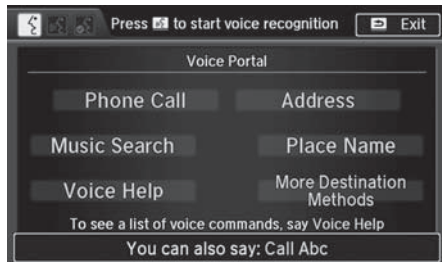
■ Searching for music using Song By Voice™ (SBV)



1. Set the **Song By Voice** setting to **On**.
2. Press the  (Talk) button and say *"Music Search"* to activate the SBV feature for the HDD and iPod.

3. Press the  button and say a command.
 - ▶ Example 1: Say *"(List) 'Artist A'"* to view a list of songs by that artist. Select the desired song to start playing.
 - ▶ Example 2: Say *"Play 'Artist A'"* to start playing songs by that artist.

4. To cancel SBV, press the  (hang-up/back) button on the steering wheel. The selected song continues playing.

▣ Searching for music using Song By Voice™ (SBV)

Song By Voice™ Commands List

▶ **Song By Voice™ (SBV)** P. 197

NOTE:

Song By Voice™ commands are available for tracks stored on the HDD or iPod.

You can add phonetic modifications of difficult words so that it is easier for SBV to recognize artists, songs, albums, and composers in voice commands.

▶ **Phonetic Modification** P. 199

SBV may not be able to recognize languages other than English for the artist name, song title, album title, and composers.



Once you have canceled this mode, you need to press the  button and say *"Music Search"* again to re-activate this mode.

Phonetic Modification



 **SETTINGS** button ▶ **System Settings** ▶ **Song By Voice Phonetic Modification**

Add phonetic modifications of difficult or foreign words so that it is easier for SBV to recognize artists, songs, albums, and composers in voice commands when searching for music on the HDD or iPod.



1. Move  and rotate  to select **New Modification**. Press .





2. Rotate  to select **HDD** or **iPod**. Press .

Phonetic Modification

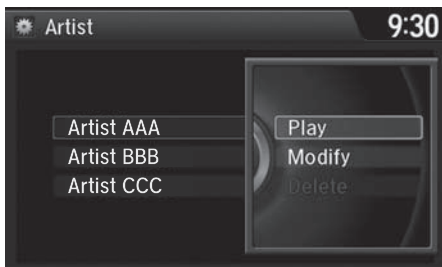

Phonetic Modification is grayed out when **Song By Voice** is set to **Off**.

You can store up to 2,000 phonetic modification items.







3. Rotate  to select the item to modify (e.g., **Artist**). Press .



▶ The list of the selected item appears on the screen.

4. Rotate  to select an entry (e.g., **No Name**). Press .



▶ The pop-up menu appears on the screen.

5. Rotate  to select **Modify**. Press .

▶ The listen to the current phonetic modification, rotate  to select **Play**. Press .





▶ To delete the current phonetic modification, rotate  to select **Delete**. Press .



6. Enter the phonetic spelling you wish to use (e.g., "Artist A") when prompted.
7. Move  to select **OK** to exit. The artist "No Name" is phonetically modified to "Artist A." When in the SBV mode, you can press the  (Talk) button and use the voice command "Play 'Artist A'" to play songs by the artist "No Name."

Selecting Internet Radio Mode

Interface Dial

1. Connect a compatible phone through *Bluetooth*®.
2. Press the **MENU** button.(in AUDIO mode)
3. Rotate  to select **Change Source**. Press .
4. Rotate  to select **Pandora*** or **Aha**. Press .

On Demand Multi-Use Display™

1. Connect a compatible phone through *Bluetooth*®.
2. Select **Audio Source**.
3. Select the Pandora* or Aha icon.

iPhone

You can also connect the phone using your dock connector to the USB port.

» Selecting Internet Radio Mode



To find out if your phone is compatible with this feature, call 1-888-528-7876 or visit acura.com/handsfreelink (U.S.) or handsfreelink.ca (Canada).

*: Pandora® is available on U.S. models only.

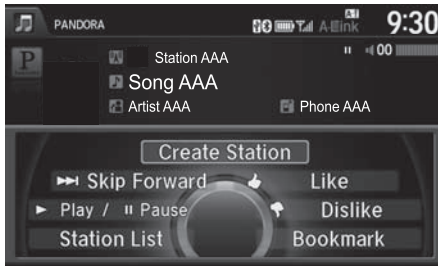
Pandora® Menu



Interface Dial

Rotate  to select an item. Press .

▶ Press **MENU** button to display the menu items.

The following items are available:

- **Skip Forward:** Skip the current song.
- **Play/Pause:** Resume or play a song.
- **Station List:** Displays the list of all your stored stations. Select a station from the list to play.
- **Like:** Likes the current song. Pandora® will play songs similar to the one liked.
- **Dislike:** Dislikes the current song and skips to the next song. Pandora® will avoid playing songs similar to the one disliked.
- **Bookmark Track:** Bookmarks the current song.
- **Bookmark Artist:** Bookmarks the current artist.
- **Create Station:** Create a new station from genre, current track, or artist.

▶▶ Pandora® Menu

Pandora, the Pandora logo, and the Pandora trade dress are trademarks or registered trademarks of Pandora Media, Inc., used with permission. Pandora® is currently available exclusively in the United States.

Pandora® is a personalized Internet radio service that selects music based on an artist, song, or genre a user enters, and streams what is likely to be of interest.

You can control Pandora® using voice commands.

▶ **Voice Control Operation** P. 6

Available operating functions vary on software versions. Some functions may not be available on the vehicle's audio system.

If there is a problem, you may see an error message on the navigation screen.

▶ **Pandora®** P. 294

To use this service in your vehicle, the Pandora® app must first be installed on your phone. Visit www.pandora.com for more information.

If you cannot operate Pandora® through the audio system, it may be streaming through *Bluetooth®* Audio.

Make sure Pandora® mode on your audio system is selected.



On Demand Multi-Use Display™

4. Select ◀ or ▶ to change a station.
5. Select ⏭ to skip a song.
 - ▶ Select ▶/|| to resume or play a song.
 - ▶ Select 👍 or 👎 to evaluate a song.
 - ▶ Select **More** to display the menu item.
 - **Adjusting the Sound** P. 156
 - **Changing the Screen Settings** P. 88

▶▶ Pandora® Menu



There are restrictions on the number of songs you can skip or dislike in a given hour.

This function is available on U.S. models only.

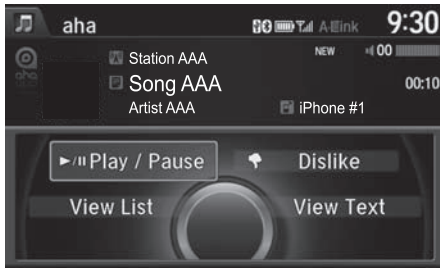
Aha™ Radio Menu



Interface Dial

Rotate  to select an item. Press .

▶ Press **MENU** button to display the menu items.

On Demand Multi-Use Display™

Select  or  to skip contents.

- Select  to resume or play a song.
- Select an icon to evaluate a song.
- Select **More** to display the menu item.

➤ **Adjusting the Sound** P. 156

➤ **Changing the Screen Settings**
P. 88

▶▶ Aha™ Radio Menu

Aha™ by Harman is a cloud-based service that organizes your favorite web content into live radio stations. You can access podcasts, internet radio, location-based services, and audio updates from social media sites.

You can control Aha™ Radio using voice commands.

➤ **Voice Control Operation** P. 6

Available operating functions vary on software versions. Some functions may not be available on the vehicle's audio system.

If there is a problem, you may see an error message on the navigation screen.

➤ **Aha™ Radio** P. 297

The menu items vary depending on the station you selected.



To use this service in your vehicle, the AcuraLink® app must be installed on your phone. Visit owners.acura.com/apps (U.S.) or www.myacura.ca/apps (Canada).

You must have a previously set up Aha™ account prior to using the service in your vehicle. Visit www.aharadio.com for more information.

How to Select a Station from the Station List

 **MENU** button (in Aha™ mode) ▶ **Station List**



Rotate  to select a station from the Station list. Press .

■ Connecting a USB Flash Drive

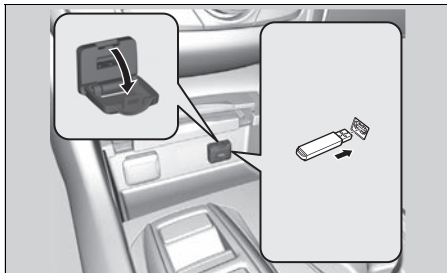

1. Open the USB cover.
2. Install the USB flash drive to the USB connector.

■ USB Flash Drives

Use a recommended USB flash drive of 256 MB or higher.

Some digital audio players may not be compatible.

Some USB flash drives (e.g., a device with security lockout) may not work.

Some software files may not allow for audio play or text data display.

Some versions of MP3, WMA, or AAC formats may be unsupported.

☒ Connecting a USB Flash Drive

- Do not connect your USB flash drive using a hub.
- Do not use a device such as a card reader or hard disc drive, as the device or your tracks may be damaged.
- We recommend backing up your data before using the device in your vehicle.

☒ USB Flash Drives





Digital music tracks, such as MP3, WMA, AAC, etc., in USB flash drives cannot be copied to HDD.

Likewise, digital music tracks recorded to HDD cannot be copied to USB flash drives.

Files on the USB flash drive are played in their stored order. This order may be different from the order displayed on your PC or device.

Selecting USB Mode

Interface Dial

1. Connect the USB flash drive to the USB port in the console compartment.
2. Press the **MENU** button. (in AUDIO mode)
3. Rotate  to select **Change Source**. Press .
4. Rotate  to select **USB**. Press .

On Demand Multi-Use Display™

1. Connect the USB flash drive to the USB port in the console compartment.
2. Select **Audio Source**.
3. Select the USB icon.

▶▶ Selecting USB Mode

You can control a USB flash drive using voice commands.

▶ **USB commands** P. 320

Files in WMA/ACC format protected by digital rights management (DRM) cannot be played.

The audio system displays Unplayable File, and then skips to the next file.

If there is a problem, you may see an error message on the navigation screen.





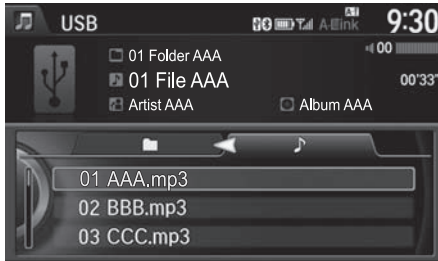

▶ **iPod/USB Flash Drive** P. 293

Audio Screen Control

Control the audio system through the navigation screen and On Demand Multi-Use Display™.







Interface Dial

1. Rotate  or Press  to display the song list.
2. Rotate , move  or  to select a song from the list. Press .
 - ▶ Press **MENU** button to display the menu items.

➤ **Audio Menu** P. 210

On Demand Multi-Use Display™

1. Select  to skip to the next folder, and  to skip to the beginning of the previous folder.
2. Select  or  to change files. Select and hold to move rapidly within a file.
 - ▶ Select **More** to display the menu item.

➤ **Audio Menu** P. 210

▶▶ Audio Screen Control

On Demand Multi-Use Display™



- **Random:**
 - Random in Folder:** Plays all files in the current folder in random order.
 - Random All Tracks:** Plays all files in random order.
- **Repeat:**
 - Repeat Folder:** Repeats all files in the current folder.
 - Repeat Track:** Repeats the current file.
- **Scan:**
 - Folders:** Provides 10-second sampling of the first file in each of the main folders.
 - Tracks:** Provides 10-second sampling of all files in the current folder.

Audio Menu

 **MENU** button (in USB mode)

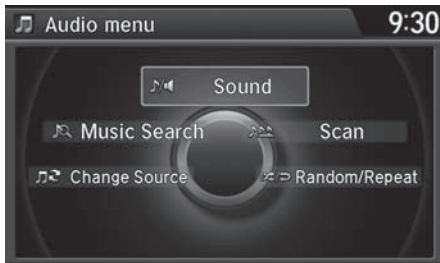
Interface Dial



Rotate  to select an item. Press .

The following items are available:

- **Sound:** Adjusts the settings of the audio speaker's sound.
 - ▶ **Adjusting the Sound** P. 156
- **Music Search:** Selects a file from the Music Search list.
 - ▶ **How to Select a File from the Music Search List** P. 212
- **Change Source:** Changes the audio source mode.
 - ▶ **Selecting Disc Mode** P. 171
- **Scan:**
 - Scan Folders:** Provides 10-second sampling of the first file in each of the main folders.
 - Scan Tracks:** Provides 10-second sampling of all files in the current folder.
- **Random/Repeat:**
 - Repeat Folder:** Repeats all files in the current folder.
 - Repeat Track:** Repeats the current file.
 - Random in Folder:** Plays all files in the current folder in random order.
 - Random All Tracks:** Plays all files in random order.

On Demand Multi-Use Display™

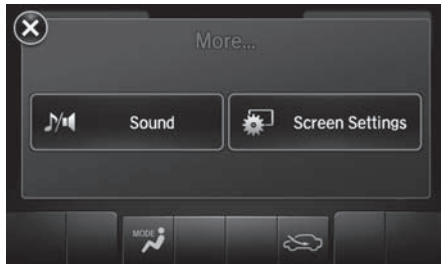

1. Select **More**.
2. Select a setting item.

The following items are available:

- **Sound**: Displays the sound preferences screen.
 - **Adjusting the Sound** P. 156
- **Screen Settings**: Displays the screen preferences screen.
 - **Changing the Screen Settings** P. 88



■ How to Select a File from the Music Search List

 **MENU** button (in USB mode) ▶ **Music Search**



1. Move  or  to select a search category. Press .



2. Rotate  to select a file from the Music Search list. Press .





Your audio system allows you to listen to music from your *Bluetooth*[®]-compatible phone.

This function is available when the phone is paired and connected to the vehicle's *Bluetooth*[®] HandsFreeLink[®] (HFL) system.

➤ ***Bluetooth*[®] HandsFreeLink[®]** P. 218

Selecting *Bluetooth*[®] Audio Mode

Interface Dial

1. Make sure that your phone is on, paired, and linked to HFL.
➤ **Phone Settings** P. 239
2. Press the **MENU** button. (in AUDIO mode)
3. Rotate  to select **Change Source**. Press .
4. Rotate  to select **Bluetooth Audio**. Press .

On Demand Multi-Use Display™

1. Make sure that your phone is on, paired, and linked to HFL.
➤ **Phone Settings** P. 239
2. Select **Audio Source**.
3. Select the *Bluetooth* icon.

▶ Playing *Bluetooth*[®] Audio

Not all *Bluetooth*[®]-enabled phones with streaming audio capabilities are compatible with the system.

For a list of compatible phones, call 1-888-528-7876 or visit www.acura.com/handsfreelink (U.S.) or www.handsfreelink.ca (Canada).

State or local laws may prohibit the operation of handheld electronic devices while operating a vehicle.

If more than one phone is paired to the HFL system, there will be a delay before the system begins to play.

You can control *Bluetooth*[®] Audio using voice commands.



➤ ***Bluetooth*[®] Audio commands** P. 320

Audio Screen Control

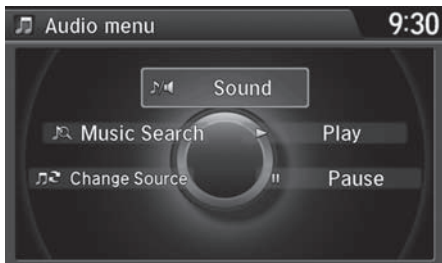
Control the audio system through the navigation screen and On Demand Multi-Use Display™.



Interface Dial

1. Press **MENU** button. (in BT mode).
2. Rotate  select an item. Press .

The following items are available:

- **Sound:** Adjusts the settings of the audio speaker's sound.
 - ▶ **Adjusting the Sound** P. 156
- **Music Search:** Selects a song from the Music Search list.
- **Change Source:** Changes the audio source mode.
 - ▶ **Selecting Disc Mode** P. 171
- **Play:** Plays a song.
- **Pause:** Pauses a song.

▶▶ Audio Screen Control

To play the audio files, you may need to operate your phone. If so, follow the phone maker's operating instructions.

The pause function and Music Search may not be available on some phones.

Switching to another mode pauses the music playing from your phone. This function may not be available on some phones.



On Demand Multi-Use Display™

1. Select ◀ or ▶ to change folders.
2. Select ◀◀ or ▶▶ to change files.
 - ▶ Select **More** to display the menu items, then select a setting item.
 - ▶ Select ▶ or || to play or pause a song file.

The following items are available:

- **Sound:** Displays the sound preferences screen.
 - **Adjusting the Sound** P. 156
- **Screen Settings:** Displays the screen preferences screen.
 - **Changing the Screen Settings** P. 88

Bluetooth® HandsFreeLink®

This section describes how to operate *Bluetooth*® HandsFreeLink®. You can place and receive phone calls using your vehicle's audio system without handling your mobile phone.

Bluetooth® HandsFreeLink®	218	Text/E-mail Message	252
Using HFL	218	Setting a Text/E-mail Message	252
Pairing a Phone	221	Selecting a Mail Account	254
Importing Phonebook Data	227	Receiving a Text/E-mail Message	255
Setting Up Speed Dialing	228	Displaying Messages	256
Phonebook Phonetic Modification	234	Roadside Assistance	260
Phone Settings	239	HFL Menus	261
Making a Call	244		
Receiving a Call	250		
Options During a Call	251		

Using HFL

HFL Buttons

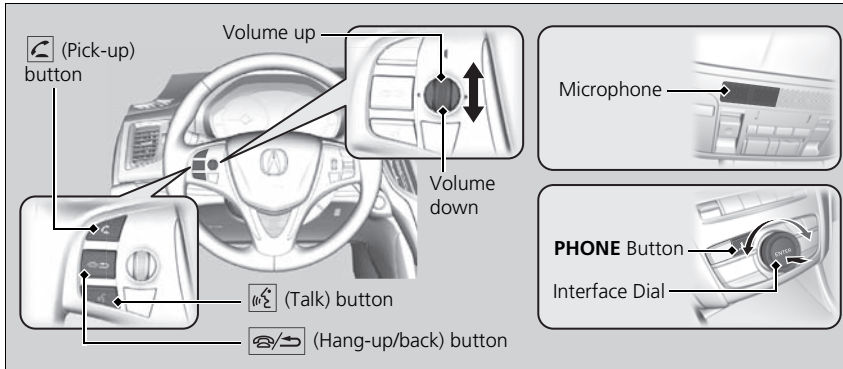

(Pick-up) button: Press to go to the **Speed Dial/Call History** on the multi-information display or to answer an incoming call.

(Hang-up/back) button: Press to end a call, to cancel a command or to clear the phone information on the multi-information display.

(Talk) button: Press to give HFL voice commands.

PHONE button: Press to go directly to the Phone screen.

Interface dial: Rotate to select an item on the screen, then press . Move , or to select secondary menu.

Bluetooth® HandsFreeLink®

To use HFL, you need a *Bluetooth*®-compatible mobile phone. For a list of compatible phones, pairing procedures, and special feature capabilities: Call 1-888-528-7876 or visit www.acura.com/handsfreelink (U.S.) or www.handsfreelink.ca (Canada).

Voice control tips:

- Aim the vents away from the ceiling and close the windows, as noise coming from them may interfere with the microphone.
- Press and release the button when you want to call a number using a stored voice tag, a phonebook name, or a number. Speak clearly and naturally after a beep.
- If the microphone picks up voices other than yours, the command may be misinterpreted.
- To change the volume level, use the audio system's volume knob or the remote audio controls on the steering wheel.

State or local laws may prohibit the operation of handheld electronic devices while operating a vehicle.

If you receive a call while using the audio system, the system resumes its operation after ending the call.

If you press button, the climate control fan speed is reduced automatically. When voice recognition ends, the fan speed returns to the previous level.

HFL Status Display

The navigation screen notifies you when there is an incoming call.

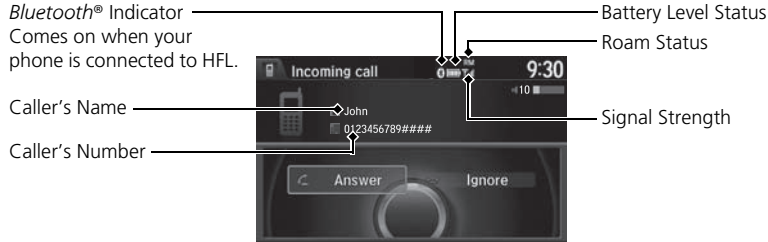

Bluetooth® HandsFreeLink®

Bluetooth® Wireless Technology

The *Bluetooth*® word mark and logos are registered trademarks owned by *Bluetooth* SIG, Inc., and any use of such marks by Honda Motor Co., Ltd., is under license. Other trademarks and trade names are those of their respective owners.

HFL Limitations

An incoming call on HFL will interrupt the audio system when it is playing. It will resume when the call is ended.

Bluetooth® HandsFreeLink® (HFL) allows you to place and receive phone calls using your vehicle's navigation system, without handling your mobile phone.

■ Limitations for Manual Operation



Disabled Option

Certain manual functions are disabled or inoperable while the vehicle is in motion.

You cannot select a grayed-out option until the vehicle is stopped.

Only previously stored speed dial entries with voice tags, phonebook names, or numbers can be called using voice commands while the vehicle is in motion.

➤ **Setting Up Speed Dialing** P. 228

➤ HFL Status Display

The information that appears on the navigation screen varies between phone models.

You can change the system language to English, French, or Spanish.

➤ **Language Settings** P. 34

Pairing a Phone

PHONE button

When no *Bluetooth*®-compatible phone is paired, the following screen appears:



1. Rotate to select **Yes**. Press .
2. Make sure your phone is in search or discoverable mode. Press .
 - ▶ HFL automatically searches for a *Bluetooth*® device.
3. When your phone appears on the list, select it by pressing .
 - ▶ If your phone does not appear, you can select **Refresh** to search again.
 - ▶ If your phone still does not appear, move to select **Phone not Found?** and search for *Bluetooth*® devices using your phone. From your phone, select **HandsFreeLink**.

▶▶ Pairing a Phone

Your *Bluetooth*®-compatible phone must be paired to HFL before you can make and receive hands-free calls.

Phone Pairing Tips:

- You cannot pair your phone while the vehicle is moving.
- Up to six phones can be paired.
- Your phone's battery may drain faster when it is connected to HFL.
- If your phone is not ready for pairing or not found by the system within three minutes, the system will time out and returns to idle.

Once you have paired a phone, you can see it displayed on the screen with one or two icons on the right side.

These icons indicate the following:

- : The phone can be used with HFL.
- : The phone is compatible with *Bluetooth*® Audio.



4. HFL gives you a pairing code on the navigation screen.
 - ▶ Confirm if the pairing code on the screen and your phone match.
This may vary by phone.
5. You will receive a notification on the screen if pairing is successful.

▶▶ Pairing a Phone

When pairing is completed, an **Automatic Phone Sync** prompt appears. Select **On** if you want your call history and phonebook automatically imported to HFL.



▶▶ **Automatic Phone Sync setting** P. 243

Some phones may have an additional setting to allow the phone to auto connect each time you turn on your vehicle.



■ Pairing from Phone Setup

PHONE button ▶ Phone Settings ▶ Connect Phone



1. Rotate  to select **Add Bluetooth Device**.
2. Make sure your phone is in search or discoverable mode. Press .
 - ▶ HFL automatically searches for a *Bluetooth®* device.



3. When your phone appears on the list, select it by pressing .
 - ▶ If your phone does not appear, you can select **Refresh** to search again.
 - ▶ If your phone still does not appear, move  to select **Phone not Found?** and search for *Bluetooth®* devices using your phone. From your phone, select **HandsFreeLink**.
4. HFL gives you a pairing code on the navigation screen.
 - ▶ Confirm if the pairing code on the screen and your phone match. This may vary by phone.
5. You will receive a notification on the screen if pairing is successful.

■ Changing the Pairing Code

🔑 **SETTING** button ▶ **System Settings** ▶ **Edit Pairing Code**



Rotate  to select **Fixed** or **Random**. Press .

▣ Changing the Pairing Code

The pairing code may be six or four digits depending on your phone.

The default pairing code is **0000** until you change the setting.





To create your own, select **Fixed**, and delete the current code, then enter a new one.

For a randomly generated pairing code each time you pair a phone, select **Random**.

■ Changing the Currently Paired Phone

🔧 **SETTING** button ▶ **Phone Settings** ▶ **Bluetooth Device List**



1. Rotate  to select a paired phone you want to replace. Press .
2. Rotate  to select **Replace This Device**. Press .
3. HFL enters the pairing process and searches a new phone.
 - ▶ Follow the prompts to pair a new phone.
4. You will receive a notification on the screen if pairing is successful.





☒ Changing the Currently Paired Phone

The replaced phone will keep the same speed dial entries, and security PIN information from the previously paired phone.



■ Deleting a Paired Phone

🔗 **SETTING** button ▶ **Phone Settings** ▶ **Bluetooth Device List**



1. Rotate  to select a paired phone you want to replace. Press .
2. Rotate  to select **Delete This Device**. Press .



3. You will receive a confirmation message on the screen. Rotate  to select **Yes**. Press .
4. You will receive a notification on the screen if deletion is successful.

Importing Phonebook Data



When your phone is paired, the contents of its phonebook and call history are automatically imported to HFL.

Importing Phonebook Data

When you select a person from the list in the mobile phonebook, you can see up to three category icons. The icons indicate what types of numbers are stored for that name.

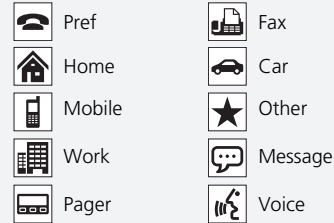

On some phones, it may not be possible to import the category icons to HFL.



The phonebook is updated after every connection. Call history is updated after every connection or call.

Setting Up Speed Dialing

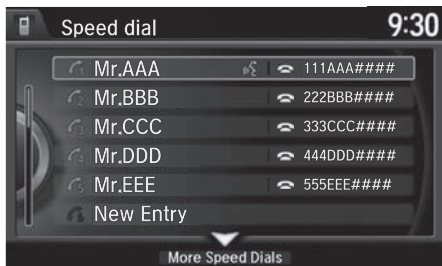

 **MENU** button (on Phone screen) ▶ **Speed Dial**

Up to 20 speed dial numbers can be stored per phone.



1. Rotate  to select **New Entry**.
Press .



2. Rotate  to select a number entry method. Press .

The following options are available:

- **Import from Call History:** Select a number from the call history.
- **Manual Input:** Input the number manually.
- **Import from Phonebook:** Select a number from the linked mobile phone's imported phonebook.





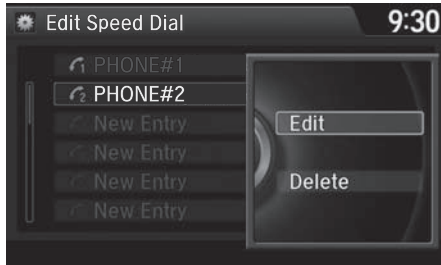

Setting Up Speed Dialing

When a voice tag is stored, press the  button to call the number using the voice tag. Say "Call" and the voice tag name.



■ Registering a Voice Tag to a Speed Dial Entry

📞 **SETTING** button ▶ **Phone Settings** ▶ **Edit Speed Dial**



1. Select an existing speed dial entry.
2. From the pop-up menu, rotate  to select **Edit**. Press .
3. Rotate  to select **Voice Tag**. Press .
4. From the pop-up menu, rotate  to select **Record**. Press .



5. Press .
 - ▶ Using the  (Talk) button, follow the prompt to enter a voice tag.

▣ Registering a Voice Tag to a Speed Dial Entry









Avoid using duplicate voice tags.

Avoid using "home" as a voice tag.

It is easier for HFL to recognize a longer name. For example, use "John Smith" instead of "John."





■ To delete a voice tag



1. Select an existing speed dial entry.
2. From the pop-up menu, rotate  to select **Edit**. Press .
3. Rotate  to select **Voice Tag**. Press .
4. From the pop-up menu, rotate  to select **Clear**. Press .
5. You will receive a confirmation message on the screen. Rotate  to select **Yes**. Press .

■ To delete a speed dial



1. Select an existing speed dial entry.
2. From the pop-up menu, rotate  to select **Delete**. Press .
3. You will receive a confirmation message on the screen. Rotate  to select **Yes**. Press .

Setting Phone Shortcuts

You can preset five previously stored speed dial entries, and make a call from one of the preset numbers, or call history when the phone is paired and connected to the vehicle's Bluetooth® HandsFreeLink® (HFL) system.

➤ **Setting Up Speed Dialing** P. 228

■ To preset a speed dial



1. Select **Shortcuts**.
2. Select **Phone**.
3. Select **Speed Dial**.
4. Select **Edit** or **No Entry**.
 - ▶ If you select **No Entry**, go to step 6.



5. Select **Add**.
 - ▶ Five presets appear. Select a **No Entry** preset or an existing preset.
 - ▶ The screen changes to a list of previously stored speed dial entries.

Setting Phone Shortcuts

Dial icon

You can make a call using the keyboard on the On Demand Multi-Use Display™ to input numbers.

➤ **Entering a Phone Number** P. 246



6. Select a number you want to store as a shortcut.

■ To make a call from a speed dial entry

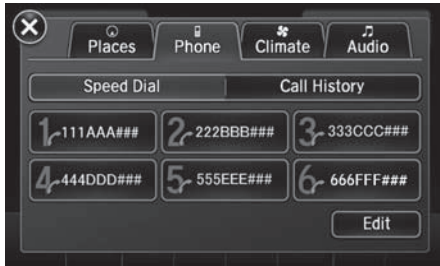

1. Select Shortcuts.
2. Select Phone.
3. Select Speed Dial.
4. Select a preset number.
 - ▶ Dialing starts automatically.

■ To delete a speed dial

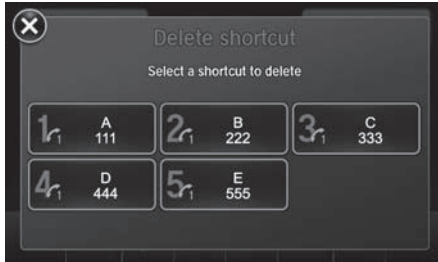

1. Select **Shortcuts**.
2. Select **Phone**.
3. Select **Speed Dial**.
4. Select **Edit**.
5. Select **Delete**.
6. Select the preset number with the phone number you want to delete.

■ To make a call from call history

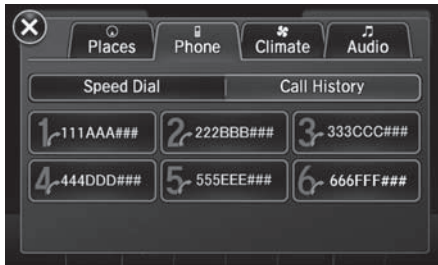

1. Select **Shortcuts**.
2. Select **Phone**.
3. Select **Call History**.
4. Select a phone number.
 - ▶ Dialing starts automatically.

☒ To make a call from call history

The call history displays the last six dialed, received, or missed calls.

Phonebook Phonetic Modification

📞 **SETTING** button ▶ **System Settings** ▶ **Phonebook Phonetic Modification**

Add phonetic modifications or a new voice tag to the phone's contact name so that it is easier for HFL to recognize voice commands.

■ To add a new voice tag

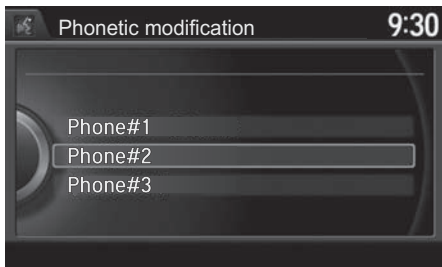

1. Rotate 📶 to select the phone you want to add phonetic modification to. Press 📞.

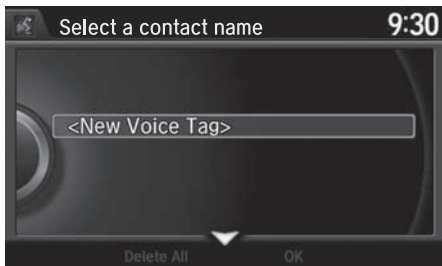



2. Rotate 📶 to select New Voice Tag. Press 📞.



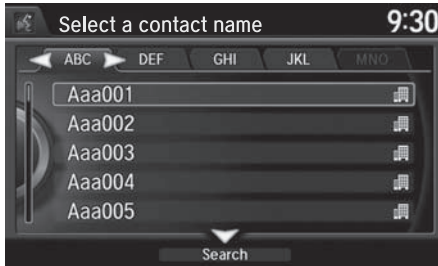



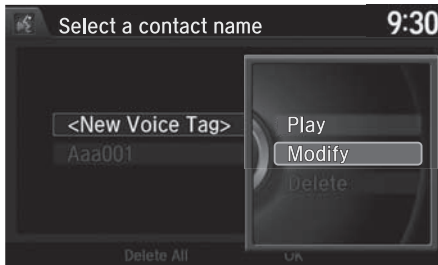

☒ Phonebook Phonetic Modification

You can store up to 20 phonetic modification items.











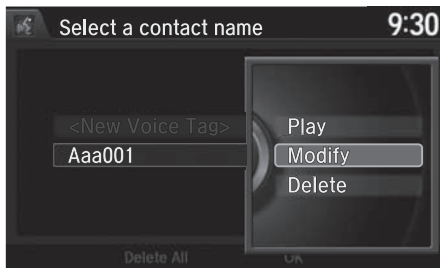

3. Move ◀○ or ○▶ and Rotate  to select a contact name. Press .
 - ▶ The pop-up menu appears on the screen.



4. Rotate  to select **Modify**. Press .
5. Using the  button, follow the prompts to complete the voice tag.
6. You will receive a confirmation message on the screen. Rotate  to select **OK**. Press .
7. The screen returns to the New Voice Tag screen. Move  and rotate  to select **OK**. Press .

■ To modify a voice tag



1. Rotate  to select the phone you want to add phonetic modification to. Press .
2. Rotate  to select a contact name you want to modify. Press .
 - ▶ The pop-up menu appears on the screen.
3. Rotate  to select **Modify**. Press .
4. Using the  button, follow the prompts to complete the voice tag.
5. You will receive a confirmation message on the screen. Rotate  to select **OK**. Press .







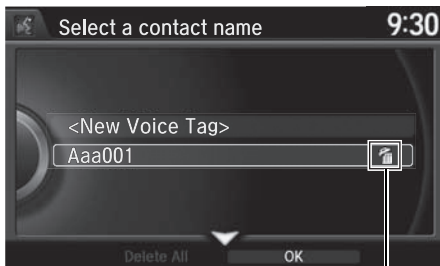
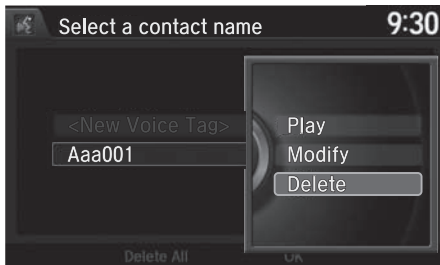
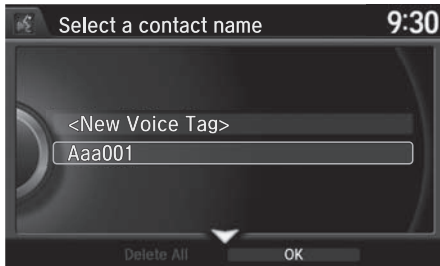

▶▶ Phonebook Phonetic Modification

You can only modify or delete contact names for the currently connected phone.

■ To delete a modified voice tag



Trash icon

1. Rotate  to select the phone you want to delete phonetic modification. Press .
2. Rotate  to select a contact name you want to delete. Press .
 - ▶ The pop-up menu appears on the screen.
3. Rotate  to select **Delete**, then press .
 - ▶ Items to be deleted are indicated with a trash icon.
4. Move  and Rotate  to select **OK**. Press .

■ To delete all modified voice tags

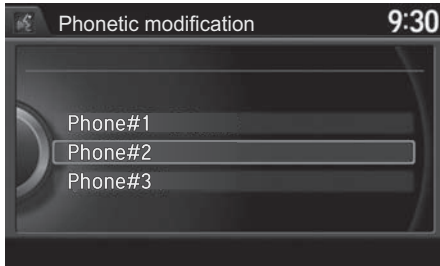

1. Rotate to select the phone you want to delete phonetic modification. Press .
▶ The contact name list appears.

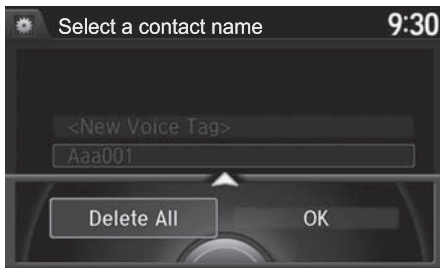

2. Move and Rotate to select **Delete All**. Press .
3. You will receive a confirmation message on the screen. Rotate to select **OK**. press .

Phone Settings







Set HFL options and features.

■ Editing a Security PIN

🔑 **SETTING** button ▶ **Phone Settings** ▶ **Bluetooth Device List**

You can protect each of the six mobile phones with a security PIN.



1. Rotate  to select the phone you want to add a security PIN to. Press .
2. Rotate  to select **Edit PIN**. Press .
3. Enter a new four-digit number. Rotate  to select **OK** to enter the security PIN.
 - ▶ Move  to delete.
4. Re-enter the four-digit number.
 - ▶ The screen returns to the screen in step 4.

✎ Editing a Security PIN

If the phone is already security PIN protected, you need to enter the current security PIN before clearing the PIN or creating a new one.

You can use the keyboard on the On Demand Multi-Use Display™ to input numbers. Select numbers, then **OK**.



Continued

■ Editing User Name

📍 **SETTING** button ▶ **Phone Settings** ▶ **Bluetooth Device List**

Edit the user name of a paired phone as follows:



1. Rotate 📶 to select a phone you want to edit. Press 📍.
2. Rotate 📶 to select **Edit Device Name**. Press 📍.

3. Enter a new name of the phone.
 - ▶ Rotate 📶 or move 📍 to select **OK** to enter the name. Press 📍.
 - ▶ Move ◀ to delete.

▶▶ Editing User Name

You can use the keyboard on the On Demand Multi-Use Display™ to input numbers.



Automatic Transferring

 **SETTING** button ▶ **Phone Settings** ▶ **Auto Transfer**

If you get into the vehicle while you are on the phone, the call can be automatically transferred to HFL.





Rotate  to select **On**. Press .

Auto Answer

 **SETTING** button ▶ **Phone Settings** ▶ **Auto Answer**

You can set HFL to automatically answer an incoming call in four seconds.



Rotate  to select **On**. Press .

■ Ring Tone

📞 **SETTING** button ▶ **Phone Settings** ▶ **Ring Tone**

You can change the ring tone setting.



Rotate 📞 to select your desired setting item. Press 📞.

The following items are available:

- **Fixed:** The fixed ring tone sounds from the speaker.
- **Mobile Phone:** The ring tone stored in the connected mobile phone sounds from the speaker.
- **Off:** No ring tones sound from the speaker.

Automatic Phone Sync setting

 **SETTING** button ▶ **Phone Settings** ▶ **Automatic Phone Sync**



Rotate  to select **On** or **Off**. Press .

Automatic Phone Sync setting

Select **On** if you want your call history and phonebook automatically imported to HFL. If prompted by your phone, please accept the import request.

Not all phones require this additional step.

Use Contact Photo

 **SETTING** button ▶ **Phone Settings** ▶ **Use Contact Photo**

You can display a caller's picture on an incoming call screen.



Rotate  to select **On**. Press .

Making a Call

You can make calls by inputting any phone number, or by using the imported phonebook, call history, speed dial entries, or redial.



▶ Making a Call

Any voice-tagged speed dial entry, phonebook name, or number can be dialed by voice from most screens. Press the  button and say "Call" and the voice tag name, "Call by name" and the phonebook name, or "Call" and the phone number.

The maximum range between your phone and vehicles is 30 ft (10 m).

Once a call is connected, you can hear the voice of the person you are calling through the audio speakers.

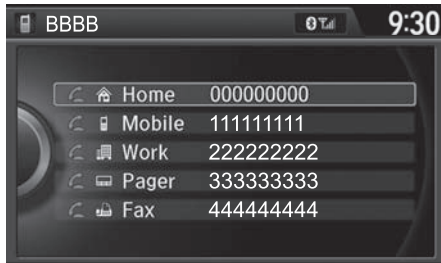

Using the Phonebook

 **MENU** button (on Phone screen) ▶ **Phonebook**



1. The phonebook is stored alphabetically. Move  to **Search**.

▶ You can use the keyboard on the touch screen for an alphabetical search.

2. Rotate  to select a number. Press .

▶ Dialing starts automatically.

Using the Phonebook

This function is disabled while the vehicle is moving. However, you can call a stored voice-tagged speed dial number, phonebook name, or number using voice commands.

▶ **Limitations for Manual Operation** P. 220

▶ **Setting Up Speed Dialing** P. 228

You can use the keyboard on the On Demand Multi-Use Display™ for an alphabetical search.



■ Entering a Phone Number

📞 MENU button (on Phone screen) ▶ Dial



1. Rotate 📞 to select a number. Press 📞.
2. Rotate 📞 to select ☑️. Press 📞.

▶▶ Entering a Phone Number

This function is disabled while the vehicle is moving. However, you can call a stored voice-tagged speed dial number, phonebook name, or number using voice commands.

- ▶▶ **Limitations for Manual Operation** P. 220
- ▶▶ **Setting Up Speed Dialing** P. 228

You can use the keyboard on the On Demand Multi-Use Display™ to input numbers. Select numbers, then ☑️ to start dialing.





■ Using Redial

 **MENU** button (on Phone screen) ▶ **Redial**

You can display a caller's picture on an incoming call screen.



Rotate  to select **Dial**. Press .

▶ Dialing starts automatically.

■ Using Call History

📞 **MENU** button (on Phone screen) ▶ **Call History**

Call history is stored by **All, Dialed, Received, and Missed**.



Navigation screen

1. Move ◀ or ▶ to select **All, Dialed, Received, and Missed**.
2. Rotate 🔄 to select a number. Press 📞.
▶ Dialing starts automatically.

Multi-information Display

1. Press the 📞 button.
2. Move the left selector wheel right to select **Call History**.
3. Roll the left selector wheel to select a number.
4. Push the left selector wheel or the 📞 button.
▶ Dialing starts automatically.

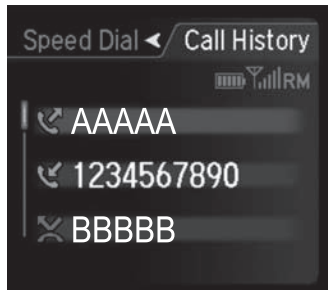

▶▶ Using Call History

The call history displays the last 20 dialed, received, or missed calls.
(Appears only when a phone is connected to HFL.)

These icons next to the number indicate the following:

- 📞: Dialed calls
- 📞: Received calls
- 📞: Missed calls

Multi-information Display



The call history displays the last 12 dialed, received, or missed calls.

■ Using Speed Dial

 **MENU** button (on Phone screen) ▶ **Speed Dial**





Navigation screen

Rotate  to select a number. Press .

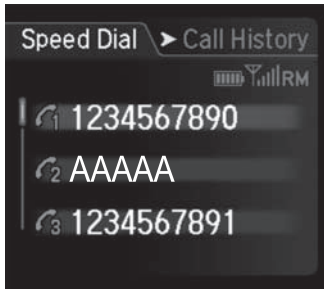
▶ Dialing starts automatically.



Multi-information Display

1. Press the .
2. Move the left selector wheel left to select **Speed Dial**.
3. Roll the left selector wheel to select a number.
4. Push the left selector wheel or the  button.
 - ▶ Dialing starts automatically.

▶▶ Using Speed Dial

Move  to select **More Speed Dials** to view another paired phone's speed dial list. You can make a call from that list using the currently connected phone.

When a voice tag is stored, press the  button to call the number using the voice tag.

▶ **Setting Up Speed Dialing** P. 228

Any voice-tagged speed dial entry, phonebook name or number can be dialed by voice from any screen. Press the  button and follow the prompts.



Multi-information Display

The speed dial displays the 20 speed dial entries.

Receiving a Call

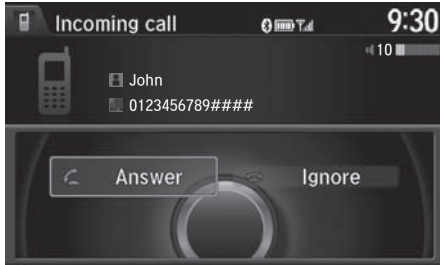
When there is an incoming call, an audible notification sounds (if activated) and the Incoming call screen appears.



1. Press the  button to answer the call.
2. Press the  button to decline or end the call.

▶▶ Receiving a Call



Call Waiting

Press the  button to put the current call on hold to answer the incoming call.

Press the  button again to return to the current call.

Ignore the incoming call if you do not want to answer it.

Press the  button if you want to hang up the current call.



You can select the icons on the On Demand Multi-Use Display™ instead of the  and  buttons.

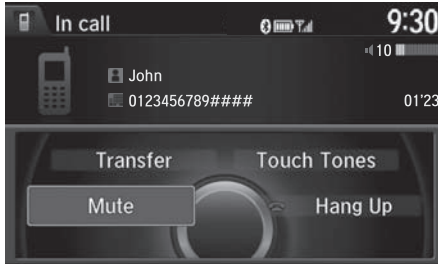

Options During a Call

The available options are shown on the Phone screen.



Rotate  to select the option. Press .

▶ The mute icon appears when **Mute** is selected. Select **Mute** again to turn it off.

The following options are available during a call:

- **Mute:** Mute your voice.
- **Transfer:** Transfer a call from HFL to your phone.
- **Touch Tones:** Send numbers during a call. This is useful when you call a menu-driven phone system.

Options During a Call

- **Touch Tones:** Available on some phones.

You can select the icons on the On Demand Multi-Use Display™.



Setting a Text/E-mail Message

To turn on or off the text/E-mail function

 **SETTING** button ► **Phone Settings** ► **Enable Text/Email**



Rotate  to select **On** or **Off**. Press .

To turn on or off the text/E-mail notice

 **SETTING** button ► **Phone Settings** ► **New Text/Email Alert**



Rotate  to select **On** or **Off**. Press .



The following items are available:

- **On:** A pop-up notification comes on every time you receive a new text message.
- **Off:** The message you receive is stored in the system without notification.

To set up the auto reading option

 **SETTING** button ▶ **System Settings** ▶ **Message Auto Reading**



Rotate  to select **On**, **Off** or **Auto**. Press .

The following items are available:

- **On**: A text/E-mail message is always read aloud.
- **Off**: A text/E-mail message is not read aloud.
- **Auto**: A text/E-mail message is read aloud only when driving.

Selecting a Mail Account

🔗 **SETTING** button ▶ **Phone Settings** ▶ **Select Account**

If a paired phone has text message or mail accounts, you can select one of them to be active and receive notifications.

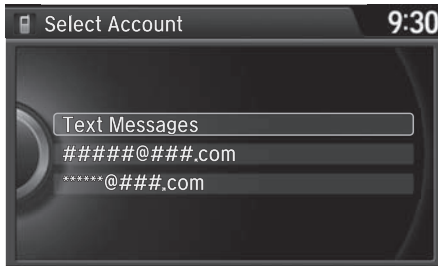

Rotate 🔄 to **Text Messages** or an E-mail account you want. Press 🔄.

🔗 Selecting a Mail Account

You can also select a mail account from the folder list screen or the message list screen. Move 📍 to select **Select Account**, then press 🔄.

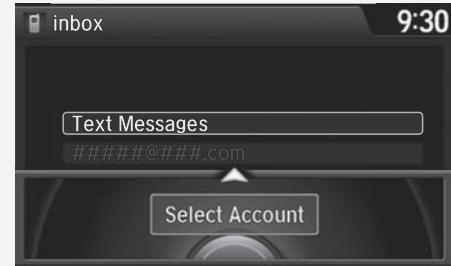

You can only receive notifications from one text message or mail account at a time.

Receiving a Text/E-mail Message

HFL can display newly received text and E-mail messages as well as 20 of the most recently received messages on a linked mobile phone. Each received message can be read aloud and replied to using a fixed common phrase.



1. A pop-up appears and notifies you of a new text or E-mail message.
2. Rotate to select **Read** to listen to the message. Press .
 - The text or E-mail message is displayed. The system automatically starts reading out the message.

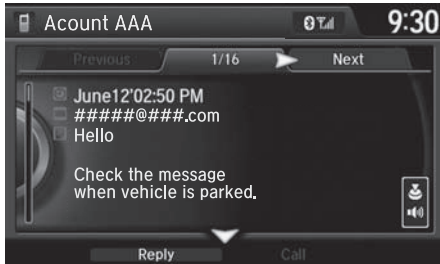

3. To discontinue the message read-out. Press .

Receiving a Text/E-mail Message

The system does not display any received messages while you are driving. You can only hear them read aloud.

With some phones, you may be able to display up to 20 most recent text and E-mail messages.

State or local laws may limit your use of the HFL text/E-mail message feature. Only use the text/E-mail message feature when conditions allow you to do so safely.

When you receive a text or E-mail message for the first time since the phone is paired to HFL, you are asked to turn the **New Text/Email Alert** setting to On.

- **To turn on or off the text/E-mail notice**
P. 252

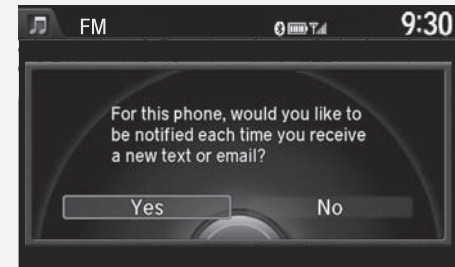



Displaying Messages

■ Displaying text messages

📞 **MENU** button (on Phone screen) ▶ **Text/Email**



1. Select account if necessary.
 2. Rotate  to select a message. Press .
- ▶ The text message is displayed. The system automatically starts reading the message aloud.

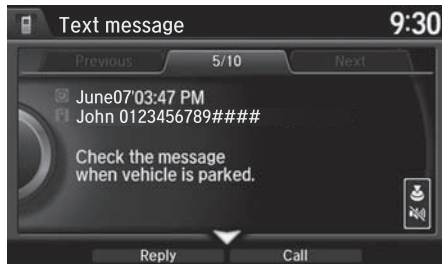

▶▶ Displaying Messages

The icon appears next to an unread message.

If you delete a message on the phone, the message is also deleted in the system. If you send a message from the system, the message goes to your phone's mailbox.



To see the previous or next message, move ◀○ or ○▶ on the text message screen.

Some phones may have an additional setting to enable this feature.



■ Displaying E-mails

 **MENU** button (on Phone screen) ▶ **Text/Email**

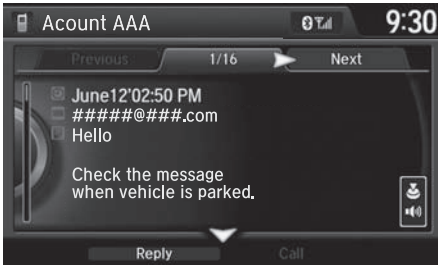

1. Rotate  to select a folder. Press .



2. Rotate  to select a message. Press .



- ▶ The text message is displayed.
- The system automatically starts reading the message aloud.

☒ Displaying E-mails

Received text and E-mail messages may appear in the message list screen at the same time. In this case, text messages are titled **No subject**.

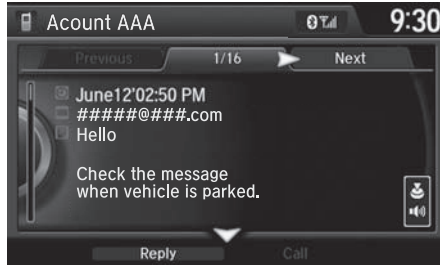

■ Read or stop reading a message



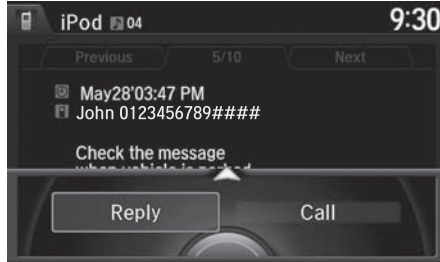

1. Go to the text or E-mail message screen.
 - ▶ The system automatically starts reading the message aloud.
 - **Displaying Messages** P. 256
2. Press  to stop reading. Press  again to start reading the message from the beginning.

■ Reply reading a message







1. Go to the text or E-mail message screen.
 - ▶ The system automatically starts reading the message aloud.
 - **Displaying Messages** P. 256
2. Move  and Rotate  to select Reply. Press .

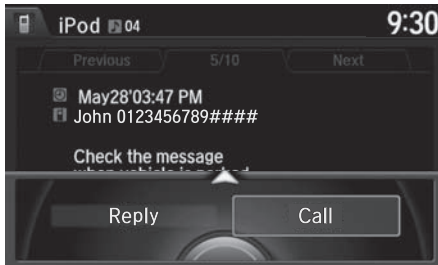

3. Rotate  to select the reply message. Press .
 - ▶ The pop-up menu appears on the screen.
4. Select **Send** to send the message.
 - ▶ **Message Sent** appears on the screen when the reply message was successfully sent.

■ Making a call to a sender



1. Go to the text message screen. The system automatically starts reading the message aloud.
 - ▶ **Displaying text messages**
P. 256
2. Move  and Rotate  to select **Call**. Press .

▶▶ Reply reading a message

The available fixed reply messages are as follows:

- Talk to you later, I'm driving.
- I'm on my way.
- I'm running late.
- OK
- Yes
- No



You cannot add, edit, or delete reply messages.

Roadside Assistance

MENU button (on Phone screen) ► Roadside Assistance

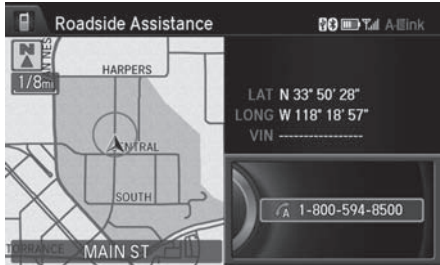
Provides a nationwide service for unexpected incidents. You can call for assistance using a phone paired and connected to *Bluetooth*® HandsFreeLink®.



Rotate  to select a phone number. Press .

► Dialing starts automatically.

Roadside Assistance

If you are subscribed to a paid AcuraLink® package, you can call the roadside assistance using the **LINK** button instead of your phone.

► **AcuraLink**® P. 266

This function is not available on all models.

The power mode must be in ACCESSORY or ON to use HFL.

■ Phone Settings screen



1. Press the **SETTINGS** button.
2. Rotate to select **Phone Settings**, then press .

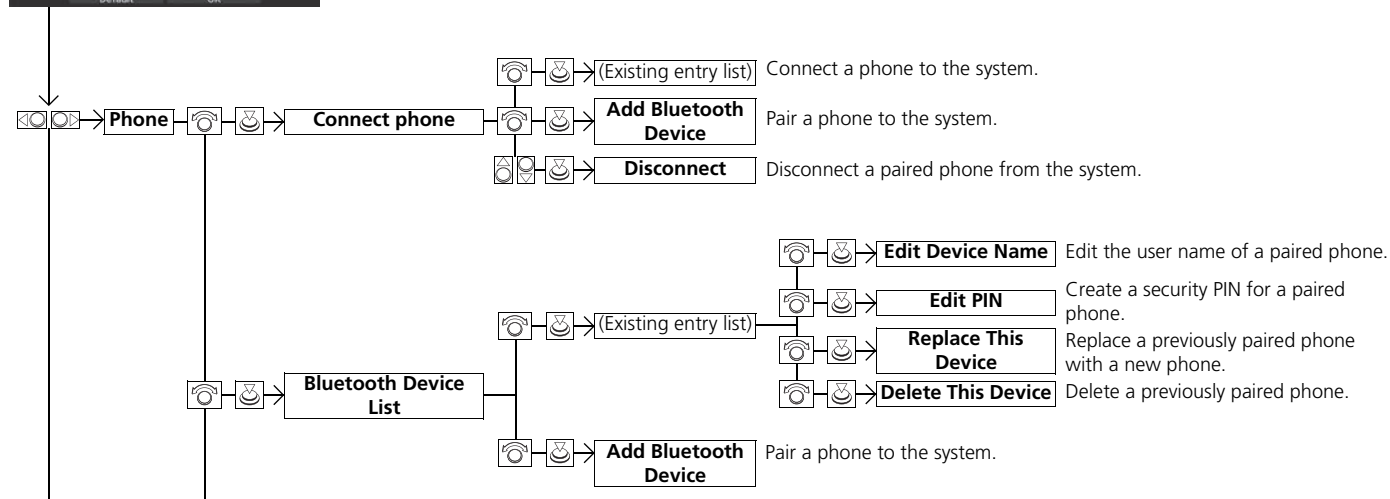

☒ HFL Menu

To use HFL, you must first pair your *Bluetooth*®-compatible mobile phone to the system while the vehicle is parked.

Some functions are limited while driving. A message appears on the screen when the vehicle is moving and the operation is canceled.

■ Phone screen



1. Press the **PHONE** button.
2. Press the **MENU** button to display the menu items.

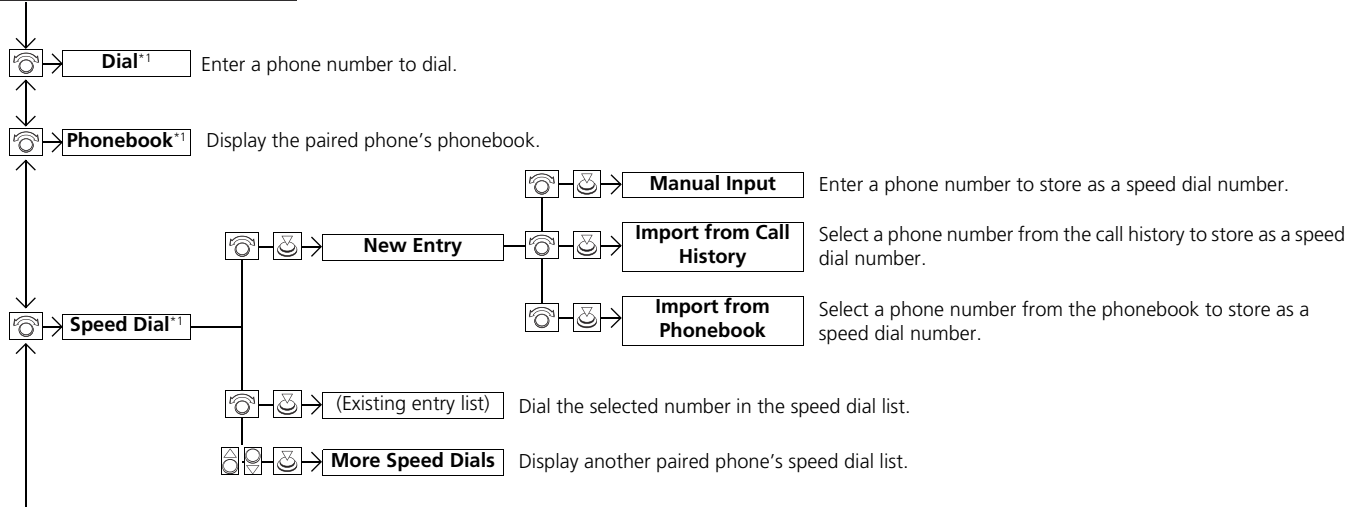

*1: Appears only when a phone is connected to HFL.

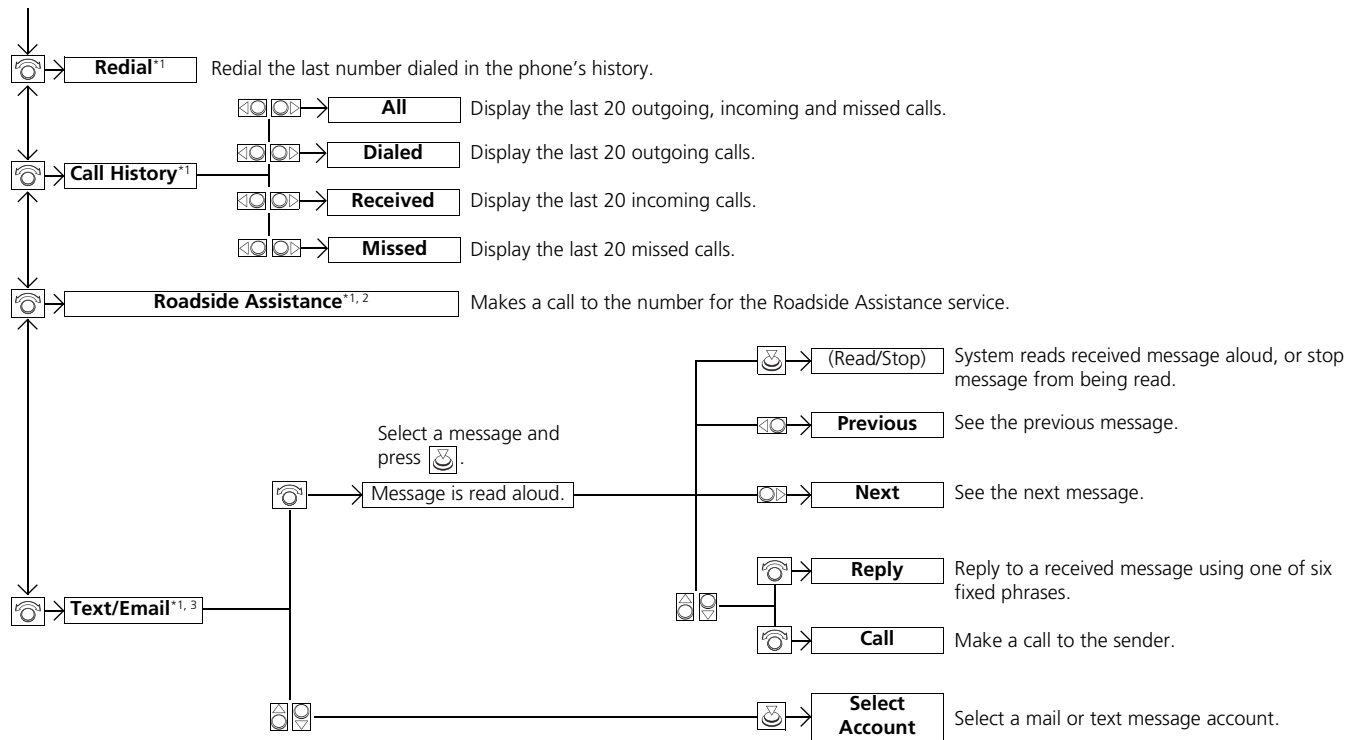

*1: Appears only when a phone is connected to HFL.

*2: Not available on all models

*3: This function is not available if your phone is not supported.

AcuraLink® Messages

This section describes how Acura directly communicates important information to you regarding your vehicle.

AcuraLink®	266
In Case of Emergency.....	266
Security Features.....	269
Operator Assistance.....	270
AcuraLink® Message.....	271
AcuraLink® Subscription Status.....	275

A subscription-based service that provides convenient features such as voice communication in case of emergency, online security, one-on-one operator assistance, and the transmission of important messages regarding your vehicle's status.

For information on traffic rerouting and traffic information updates, provided by the AcuraLink® server.

In Case of Emergency

Your vehicle may not be able to connect to the operator if the battery level is low, the line is disconnected or you do not have adequate mobile coverage.

You cannot use emergency services when:

- You travel outside the AcuraLink® service coverage areas.
- There is a problem with the connecting devices, such as the **ASSIST** button, microphone, speakers, or the unit itself.
- You are not subscribed to the service or your subscription is no longer valid.

» AcuraLink®

AcuraLink® also provides services you can operate from the Internet or your smartphone.

To subscribe to AcuraLink®, or to get more information about all of its features, contact an Acura dealer or visit owners.acura.com (U.S.) or www.myacura.ca (Canada).

» In Case of Emergency

You cannot operate other navigation- or phone-related functions using the screens while talking to the operator.

Only the operator can terminate the connection to your vehicle.

Automatic collision notification

Navigation screen

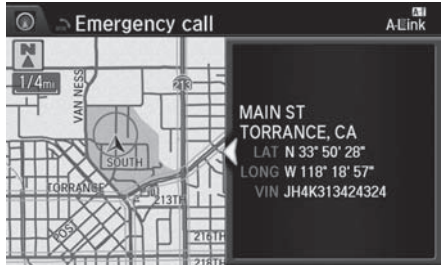

If your vehicle's airbags deploy or if the unit detects that the vehicle is severely impacted, your vehicle automatically will attempt to connect to the AcuraLink® operator. Once connected, information about your vehicle, its positioning, and its condition will be sent to the operator; you also can speak to the operator when connected.

On Demand Multi-Use Display™



Automatic collision notification

If the unit fails to connect to the operator, it repeatedly tries until it succeeds.

■ Manual operator connection

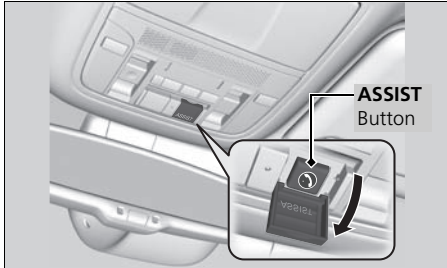

If you need to talk to the AcuraLink® operator in an emergency situation, you can manually connect to them by pressing the **ASSIST** button with the power mode in ACCESSORY or ON.

1. Open the cover attached to the ceiling console.
2. Press the **ASSIST** button.
 - ▶ You are connected to the AcuraLink® operator.

☒ Manual operator connection

Do not press the button while driving. When you need to contact the operator, park the vehicle in a safe place.

If the unit fails to connect to the operator, it automatically cancels the action after three minutes.

In an emergency, the cover can be broken through to press the **ASSIST** button.

Security Features

Your subscribed telematics service provider can track your vehicle's location, remotely lock or unlock doors, and help you find your vehicle.

To use these features, you need your user ID and personal identification number (PIN).

■ Stolen vehicle tracking

This feature searches and tracks down your vehicle position even if it is on the move. If you believe that your vehicle has been stolen, contact the police as well as the provider.

■ Remote door lock/unlock

The provider can remotely lock or unlock doors upon your request.

■ Vehicle finder

This feature is convenient to use when trying to locate your vehicle in large areas, such as a crowded parking lot. If you cannot locate your vehicle after using the remote transmitter's answerback function, you can contact the provider which can then flash your vehicle's exterior lights and sound the horn.

■ Security alarm notification

If the security system in your vehicle detects an abnormal condition, such as someone tampering with the lock on your vehicle, the provider notifies you by your preferred method.

☒ Security Features

The contact information of your provider, your user ID and PIN will be given when you subscribe to AcuraLink®. If you forget any of the above, contact a dealer or visit owners.acura.com (U.S.) or www.myacura.ca (Canada).

You can also activate the remote door lock/unlock and vehicle finder features from the Internet or using your smartphone app. Ask a dealer or visit owners.acura.com (U.S.) or www.myacura.ca (Canada).

☒ Vehicle finder

The lights will stop flashing and horn will stop sounding under the following conditions:

- When 30 seconds have elapsed.
- You unlock the doors using the remote transmitter.
- You unlock the doors using the keyless access system.
- You unlock the doors using the built-in key.
- The power mode is set to ACCESSORY or ON.

Operator Assistance

Connect to the AcuraLink® operator when trying to find a destination or for roadside assistance.

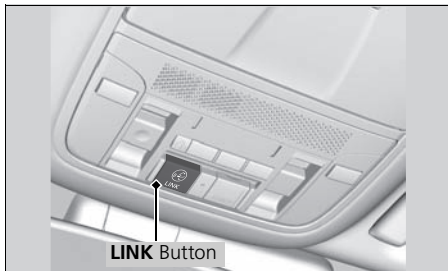

1. Press the **LINK** button.
 - ▶ Connection to the operator begins.

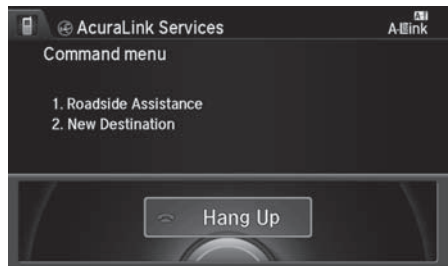

2. Talk to the operator.
 - ▶ To disconnect, rotate  to select **Hang Up**, select **End Call** on the On Demand Multi-Use Display™, or press the **Hang-up** button.

Operator Assistance

Remain attentive to road conditions and driving during operator assistance.

AcuraLink® Message

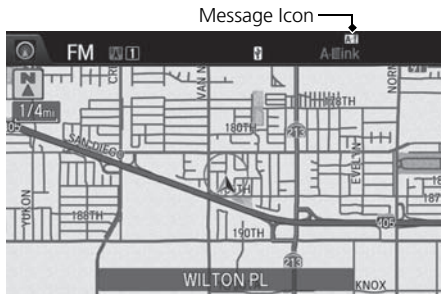



AcuraLink® sends you messages on vehicle features, safety and emissions recall campaigns, maintenance reminders, and diagnostic information.

When you receive a new message, an icon appears on the upper right corner of the navigation screen.

✉ AcuraLink® Message

Messages may not appear immediately after your vehicle purchase. It can take several days for your dealer to register your vehicle's ID.

If an icon includes an exclamation point, it indicates that Acura gives high priority to this message compared to the one without.

- : An unread message with high priority
- : An unread message

✉ Message category

The types of messages you receive can be modified. Ask a dealer or visit owners.acura.com (U.S.) or www.myacura.ca (Canada).

You can call your dealer, find the nearest dealer, or schedule appointments from the message options in Maintenance Minder, Recalls/Campaigns, and Diagnostic Info.

✉ **Message Options** P. 273

Message category

There are six message categories.







- **Feature Guide:** Messages about your vehicle and its features are sent daily for the first 90 days.
- **Quick Tips:** Supplements your Owner's Manual with updated vehicle information.
- **Diagnostic Info:** Appears when a warning indicator or message comes on. Rotate  to select Check Later or Check Now.
 - ▶ Selecting Check Now lets you know if you should see a dealer immediately or later in accordance with the warning severity level.
- **Scheduled Dealer Appointment:** An appointment made through the Acura server or Acura Owners website can be rescheduled or canceled from this option.
 - ✉ **Dealer Appointments** P. 274
- **Maintenance Minder:** Lets you know which maintenance item is due along with a reminder message.

Continued

- **Recalls/Campaigns:** Reminds you of a recall or important safety information. You should also be notified by mail.

Reading a message



1. Press the **INFO** button, rotate  to select **AcuraLink/Messages**, then press .
 - ▶ If your display has changed from Info menu to **Current Drive**, press the **MENU** button.
 - ▶ Select **AcuraLink messages**.
2. Rotate  to select a category, then press .
 - ▶ If there are unread messages in a category, a message icon appears next to that category.
3. Rotate  to select a message you want to read, then press .

Reading a message

If there is no message listed on the menu, **AcuraLink/Messages** is grayed out and cannot be selected.

The message icon disappears once you read the message.

However, the exclamation mark that indicates that the message has a high priority remains.

- : A read message with high priority.

Message Options



While a message is displayed, you can use options to take immediate action to the message.

Available options are:

- **Voice:** Reads the message aloud. Select Stop to cancel it.
- **Find Acura Dir.:** Searches for the nearest Acura dealer.
- **Delete:** Deletes the displayed message.
- **Call Your Dealer:** Calls your Acura dealer using HFL.
- **Schedule Dealer Appointment:** Automatically sets an appointment date at your dealer.
- **Phone number:** Dials a number displayed in the message via HFL.
- **Diagnostic Info:** Updates the current diagnostic message by connecting to the Acura server using HFL.

Message Options

The available options vary by message category.





You can delete all messages in a category at once.

Voice is available only when the **Message Auto Reading** setting is in ON, and the language selected is English.

■ Dealer Appointments

You can confirm the scheduled appointment date when you receive a **Maintenance Minder** or **Recalls/Campaigns** message, or reschedule any existing appointments.



1. Select a **Maintenance Minder**, **Recalls/Campaigns**, or **Scheduled Dealer Appointment** message.
2. Rotate  to select **Scheduled Dealer Appointment** or **Reschedule Appointment** (depending on the screen). Press .
 - ▶ A suggested time and date are displayed.
3. Rotate  to select **Confirm Appointment**. Press  to accept the time and date.
4. Press  to select **OK**.

▣ Dealer Appointments

To set up an automated dealer appointment when a regular maintenance is due, visit the Acura Owners website at owners.acura.com (U.S.) or www.myacura.ca (Canada) and set the required option. A reminder message will be sent as the date for the dealer appointment approaches. A reminder message will also be sent if you schedule an appointment online using the Schedule Service Appointment function.

If you are not satisfied with the proposed appointment date and time, call your dealer directly.

To cancel the scheduled appointment, select **Cancel Appointment** when a message is displayed.

AcuraLink® Subscription Status

 **SETTINGS** button ▶ **Info Settings** ▶ **AcuraLink Subscription Status**

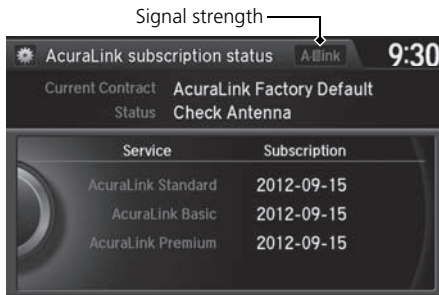

Confirm your AcuraLink® subscription status.

Item	Information
A-link	You can check the signal strength.
Current Contract	The AcuraLink® subscription number and subscription level is displayed.
Service	You can confirm the type of service.
Subscription	You can confirm the expiration date.
Status	The following message can be displayed: <ul style="list-style-type: none"> • Check Antenna: There is a problem with the AcuraLink® antenna. Contact a dealer. • No data: The signal is received, but the system cannot receive traffic data. • OK: The system is receiving the signal or traffic data.

Other Features

This section describes the useful functions incorporated into the navigation system.

Trip Computer	278
Calendar	279
Information Functions	280
System Device Information	280
Map Data Update	280
Info Screen Preference	281

INFO button ► Trip Computer

View the distance traveled and average fuel consumption.

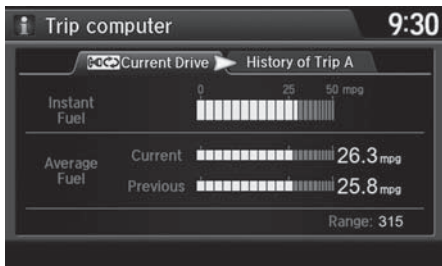

Move ◀ or ▶ to select the trip information.

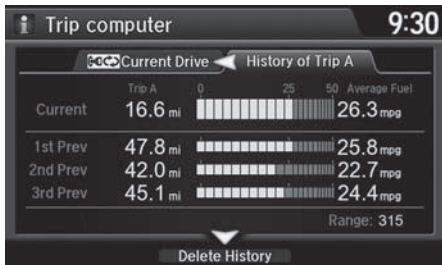

The following items are available:

- **Current Drive:** Displays the current trip information.
- **History of Trip A:** Displays information for three previous histories. The information is stored every time you reset Trip A.
- **Delete History:** Deletes the trip information. Move ◂ on the Trip A screen to select **Delete History**, then press ⏏. You will receive a confirmation message on the screen. Rotate ⌚ to select **Yes**, then press ⏏.

» Trip Computer

Displays the following trip information:

- **Instant Fuel:** The current estimated instant fuel economy.
- **Average Fuel:** The average fuel economy since the last key cycle.
- **1st, 2nd, 3rd Prev.:** The previous average fuel consumption.
- **RANGE:** The estimated distance you can travel on the fuel remaining in the tank.

These values are estimates only.

 **INFO** button ► **Calendar**

View the calendar screen.



Move ◀ or ▶ to select the months of the year.

System Device Information

🔍 **SETTINGS** button ▶ **Navi Settings** ▶ **Map** ▶ **System Device Information**

View database, software, device, and vehicle identification information.



Map Data Update

🔍 **SETTINGS** button ▶ **Navi Settings** ▶ **Map** ▶ **Map Data Update**

Check the map data update status when updating the map database.

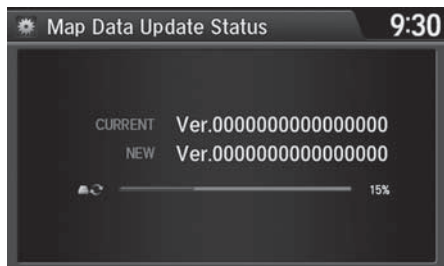

System Device Information

You will need this information when ordering a map update.

➔ **Obtaining a Navigation Update** P. 306

Map Data Update

This operation is only available during a database update.

➔ **Obtaining a Navigation Update** P. 306

Info Screen Preference

🔧 **SETTINGS** button ▶ **Info Settings** ▶ **Other** ▶ **Info Screen Preference**

Select the top menu when the **INFO** button is pressed.



Rotate 🔄 to select your desired setting item. Press 🏠.

The following options are available:



- **Info Top**: A brief menu pops up.
- **Info Menu** (factory default): A full menu pops up.
- **Off**: A menu does not pop up.

Troubleshooting



Troubleshooting	284
Map, Voice, Entering Destinations	284
Traffic	286
Guidance, Routing	287
Update, Coverage, Map Errors	289
Display, Accessories	289
Miscellaneous Questions	289
Error Messages	290
Navigation System	290
CD Player	291
Hard Disc Drive (HDD) Audio	292
iPod/USB Flash Drive	293
Pandora®	294
Aha™ Radio	297

Map, Voice, Entering Destinations

Problem	Solution
The Startup Confirmation screen is displayed every time I start the car.	This is normal. The Startup Confirmation screen reminds you and your guest drivers to always operate the navigation system in a safe manner. The Startup Confirmation screen goes off after a certain period of time and the top screen of the last mode is displayed.
The navigation system reboots by itself (returns to the opening screen).	A reboot can be caused by extreme temperatures or shock from bumpy roads, and does not necessarily indicate a problem. If this happens frequently, please see a dealer.
How do I specify a destination when an entered city or street could not be found?	<ul style="list-style-type: none"> • Try entering the street first. Some cities are lumped in with a major metro area. In rural "unverified" areas or new subdivisions, streets may be missing or only partially numbered. • Try selecting the destination directly from the map. <p> Map Input P. 112</p>
Why do some letters become grayed out when I enter an address?	As you enter each letter in an address or a place/landmark, the navigation system looks in the database to see what letters are possible and grays out letters that do not apply.
How do I delete Personal Addresses, Previous Destinations, or the Home Address?	<ol style="list-style-type: none"> 1. Press the SETTINGS button. Select Navi Settings > Personal Info to display the types of information. 2. Select the type of address to delete. 3. Select Delete.
I cannot hear the navigation system voice.	<ol style="list-style-type: none"> 1. Press the SETTINGS button. Select System Settings and check that Guidance Volume is not set to 0. 2. Select Voice Reco and set Voice Prompt to On.
Why is Call grayed out on the Calculate Route screen?	Your phone is not paired to Bluetooth® HandsFreeLink® or, if paired, your phone is in use.  Bluetooth® HandsFreeLink® P. 218





Problem	Solution
The voice control system is having difficulty recognizing my voice commands.	<ul style="list-style-type: none"> Check that the vents are not blowing air onto the microphone on the ceiling, the vehicle is as quiet as possible, and you are using the correct command when speaking. <ul style="list-style-type: none"> ▶ Voice Recognition P. 23 Say  "Voice Help" on any screen to see a list of the applicable voice commands.
I cannot give voice commands.	<p>Make sure you selected OK at the Startup Confirmation screen.</p> <ul style="list-style-type: none"> ▶ Start-up P. 20
I cannot select an option using the Interface Dial.	<p>To reduce potential driver distraction, certain onscreen functions and features are limited or inoperable while the vehicle is moving. Use voice commands or pull over to proceed.</p>
The navigation system pronunciation of street names in the guidance command or destination address sounds strange.	<p>The basic guidance phrases use a studio-recorded voice, but street names are pronounced using a machine-generated voice. Consequently, the name may be mispronounced or sound strange at times.</p>
The screen is bright when I drive at night.	<ol style="list-style-type: none"> Check that the nighttime dashboard brightness control is not set to maximum. Press the SETTINGS button. Select Navi Settings > Map > Color (Night). <ul style="list-style-type: none"> ▶ Color P. 73
The screen is dark when I drive during the day.	<p>Press the SETTINGS button. Select Navi Settings > Map > Color (Day).</p> <ul style="list-style-type: none"> ▶ Color P. 73
How do I change or remove my PIN?	<ol style="list-style-type: none"> Press the SETTINGS button. Select Navi Settings > Personal Info > PIN Number > Address Book PIN or Go Home PIN. Enter your existing PIN. You then have the choice to change or remove the PIN. <ul style="list-style-type: none"> ▶ PIN Numbers P. 47
I have forgotten my PIN. How do I reset the PIN for Home or the PIN for personal addresses?	<p>A dealer must reset the PIN for you.</p>

Traffic

Problem	Solution
<p>AcuraLink Real-Time Traffic™ information could not be received or is not displayed properly.</p>	<ul style="list-style-type: none"> • Check that the traffic status indicator is available on the map screen. <ul style="list-style-type: none"> ➤ AcuraLink Real-Time Traffic™ P. 14 • Check that the traffic icons are turned on. <ul style="list-style-type: none"> ➤ Showing Icons on Map P. 71 • Check the AcuraLink® subscription status. <ul style="list-style-type: none"> ➤ AcuraLink® P. 266 • There may be a temporary technical problem in your metropolitan area. Call Acura Client Relations to see if there is an outage. <ul style="list-style-type: none"> ➤ Acura Client Relations Contact Information P. 304 • If the situation persists, see your Acura dealer for assistance. • AcuraLink® is not available in Alaska, Hawaii, Puerto Rico, and Mexico.
<p>The navigation system sometimes provides a detour route when I am driving a route on the freeway/ highway.</p>	<p>If Traffic Rerouting is set to On, the navigation system provides a detour route to your destination only if it can find a significantly faster route than the original one.</p> <ul style="list-style-type: none"> ➤ Traffic Rerouting P. 58
<p>The navigation system routes me to an exit and an alternate freeway/highway with unknown flow speeds or surface streets.</p>	<p>The navigation system predicts which route should be faster based on freeway/ highway congestion along your route. Use your own experience to determine whether the alternate route would be faster.</p>
<p>How can I ignore the detour route and return to the original route?</p>	<p>Press the SETTINGS button. Select Navi Settings > Routing, and set Traffic Rerouting to Off.</p> <ul style="list-style-type: none"> ➤ Traffic Rerouting P. 58

Guidance, Routing

Problem	Solution
The navigation system does not route me the same way I would go or the same way as other mapping systems.	The navigation system attempts to generate the optimal route. You can change the route preferences used when calculating a route. ➤ Route Preference P. 54
The navigation system wants to route me around potential traffic problems. How do I stop these pop-up messages?	Press the SETTINGS button. Select Navi Settings > Routing , and set Traffic Rerouting to Off . ➤ Traffic Rerouting P. 58
The street I'm on is not shown on the map screen.	The mapping database is constantly undergoing revision. You can access the most recent information on the internet. ➤ Map Coverage P. 305
The vehicle position icon is not following the road and the "GPS icon" text in the upper left hand corner of the screen is white or missing.	<ul style="list-style-type: none"> • Check that the GPS antenna (located in the dashboard) is not blocked. For best reception, remove items from the dashboard, such as radar detectors, mobile phones, or loose articles. • Metallic tinting or other aftermarket devices can interfere with the GPS reception. Please consult a dealer. ➤ GPS System P. 302
The blue highlighted route and voice guidance stopped or turned into a blue/pink line before I got to my destination.	Your route has entered an unverified area. ➤ Unverified Routing P. 56
How do I stop the map from rotating as I drive along?	Press the SETTINGS button. Select Navi Settings > Map > View > North-Up , or say  "Display north-up" to change the map orientation.
The "time to destination" display sometimes increases even though I am getting closer to my destination.	If your speed reduces due to slower traffic, the navigation system updates the "time to destination" based on your actual road speed to give you a better estimate of arrival time.

Problem	Solution
The vehicle position icon on the map “lags” a short distance behind, especially when I arrive at an intersection.	This is normal. The navigation system is unaware of the width of intersections. Large differences in vehicle position can indicate a temporary loss of the GPS signal.  GPS System P. 302
The screen is showing white dots as I drive along.	These dots are called “breadcrumbs.” These are displayed if Display Tracking is set to On .
How do I remove the white dots (“breadcrumbs”) from my screen?	Press the SETTINGS button. Select Navi Settings > Map , set Display Tracking to Off or select Delete Tracking to remove the white dots from the map.  Display Tracking P. 84
A road that I selected to avoid is being used when routing.	When you “draw” your area to avoid, make sure to select sections of roads that include at least one intersection.  Avoided Area P. 60
My elevation (shown when I display the current position) seems to fluctuate even though my elevation has not changed.	This is normal. The elevation can vary ± 100 ft (± 30 m) due to GPS calculation errors.  GPS System P. 302
My elevation is missing on the “current position” screen.	The elevation is only displayed if the GPS antenna can receive signals from at least four satellites. Try moving the vehicle into an open area. The elevation is also not displayed if the calculated elevation is zero or below sea level.

Update, Coverage, Map Errors

Problem	Solution
My city is not part of a fully verified detailed coverage area.	The mapping database is constantly undergoing revision. You can access the most recent information on the internet. ➤ Map Coverage P. 305
Does the navigation system work outside North America?	The navigation system contains maps for the 50 U.S. states, Canada, Puerto Rico, and Mexico. The navigation system will not work in other countries. ➤ Map Coverage P. 305
How do I report errors I find in the database?	Minor errors are bound to occur in a large database. If you encounter major errors, see ➤ Reporting Errors P. 304

Display, Accessories

Problem	Solution
The display appears dim when starting the car in really cold weather.	This is normal. The display will become brighter after a few minutes.

Miscellaneous Questions





Problem	Solution
My battery was disconnected or went dead, and the navigation system is asking for a code.	Set the power mode to ON, and press and hold the  (Power) button for two seconds. The system should reactivate. If you have installed an aftermarket system, contact a dealer.

Navigation System

Error Message	Solution
The display temperature is too high. For protection, the system will shut off until the display cools down.	This message appears briefly when the display temperature is too high. The navigation system turns off until the display cools down. The system turns back on automatically when the display cools down.
The navigation system temperature is too low. For protection, the system will shut off until it warms up.	The navigation system has difficulty reading the HDD when the temperature is below approximately -22°F (-30°C). The navigation system starts up automatically when the display warms up.
The navigation system atmospheric pressure is too low. For protection, the system will shut off until the pressure returns to safe levels.	The HDD is inoperable due to low atmospheric pressure. Move your vehicle to the place where the atmospheric pressure is high.
The navigation system temperature is too high. For protection, the system will shut off until it cools down.	The navigation system has difficulty reading the HDD when the temperature is high. The navigation system starts up automatically when the system cools down.
HDD access error. Please consult your dealer.	Writing of the data to the HDD failed with a cause other than low temperature, high temperature, and low atmospheric pressure. After a short wait, try to operate the system again. If this does not solve the problem, consult with the dealer.
HDD access error. The system will reset and attempt to correct the problem.	

CD Player

If a disc error occurs, you may see the following error messages.

Error Message	Cause	Solution
Unplayable File	Track/file format not supported	<ul style="list-style-type: none"> Current track/file will be skipped. The next supported track/file plays automatically.
Bad Disc Please Check Owner's Manual Push Eject	Mechanical error	<ul style="list-style-type: none"> Press the  (eject) button and remove the disc, and check that the error message is cleared.
Mecha Error		<ul style="list-style-type: none"> Check that the disc is not damaged or deformed, and insert the disc again.  Protecting CDs P. 177
Bad Disc Please Check Owner's Manual	Servo error	<ul style="list-style-type: none"> If the error message reappears, press the  (eject) button, and pull out the disc. Insert a different disc. If the new disc plays, there is a problem with the first disc. If the error message repeats, or the disc cannot be removed, contact a dealer. Do not try to force the disc out of the player.
Check Disc	Disc error	<ul style="list-style-type: none"> Check that the disc is not damaged or deformed.  Protecting CDs P. 177
Heat Error	High temperature	<ul style="list-style-type: none"> Turn the audio system off and allow the player to cool down until the error message is cleared.

Hard Disc Drive (HDD) Audio

If an error occurs while playing the Hard Disc Drive (HDD) Audio, you may see the following error messages. If you cannot clear the error message, contact a dealer.

Error Message	Cause
HDD access error. Please consult your dealer.	—
The navigation system temperature is too high. For protection, the system will shut off until it cools down.	Turn the audio system off and allow the player to cool down until the error message is cleared.
The navigation system temperature is too low. For protection, the system will shut off until it warms up.	The navigation system has difficulty reading the HDD when the temperature is below approximately -22°F (-30°C). The navigation system starts up automatically when the display warms up.
Unplayable File	Appears when a file format not supported. Current track will be skipped. The next supported track plays automatically.

iPod/USB Flash Drive

If an error occurs while playing an iPod or USB flash drive, you may see the following error messages. If you cannot clear the error message, contact a dealer.

Error Message	Cause
USB Error	Appears when there is a problem with the audio system. Check if the device is compatible with the audio system.
Incompatible USB Device Please Check Owner's Manual	Appears when an incompatible device is connected. Disconnect the device. Then turn the audio system off, and turn it on again. Do not reconnect the device that caused the error.
Unsupported Version Connect Retry	Appears when an unsupported iPod is connected. If it appears when a supported iPod is connected, update the iPod software to the newer version. Appears when the system does not acknowledge the iPod. Reconnect the iPod.
Unplayable File	Appears when the files in the USB flash drive are DRM or an unsupported format. This error message appears for about 3 seconds, then plays the next song.
No Data	<p>iPod Appears when the iPod is empty.</p> <p>USB flash drive Appears when the USB flash drive is empty or there are no MP3, WMA, or AAC files in the USB flash drive.</p> <p>iPod and USB flash drive Check that compatible files are stored on the device.</p>
Unsupported	Appears when an unsupported device is connected. If it appears when a supported device is connected, reconnect the device.

U.S. models

Pandora®

If an error occurs while playing Pandora®, you may see the following error messages.

If you cannot clear the error message, contact a dealer.

Error Message	Cause	Solution
Incompatible USB Device Please Check Owner's Manual	Appears when an incompatible device is connected.	Disconnect the device. Then turn the audio system off, and turn it again. Do not reconnect the device that caused the error.
Navigation Screen There is no station list in the device. Please add the station list to your device. On Demand Multi-Use Display™ No stations have been created. Please create a station on the device.	Appears when there is no station list on the device.	Use the device to create a station.
Music licenses force us to limit the number of tracks you may skip each hour.	Appears when you try to skip a song or select Dislike over the predetermined number of times in an hour.	Try again later.
Unable to save rating. Unable to save bookmark.	Appears when the commanded operation is failed.	Try again later.
No data	Appears when no data is available with Pandora® activated.	Reboot the app and reconnect the device.
Unsupported PANDORA App version is not supported.	Appears when Pandora® version is not supported.	Update Pandora® to the latest version.
PANDORA system maintenance	Appears when the Pandora® server is in maintenance.	Try again later.

Error Message	Cause	Solution
Cannot connect to PANDORA. When stopped, check your mobile device.	<p>The Pandora® app failed to start because of the following device errors:</p> <ul style="list-style-type: none"> • The display on your smartphone is turned off. • Your smartphone is locked. • The home screen or the app screen (music screen) is not displayed on your smartphone. • The track is not played on your smartphone even after 30 seconds have passed. • The Pandora® app is not installed in your device, or the Pandora® version is not supported. 	<ul style="list-style-type: none"> • Turn the phone screen on, and make sure it is unlocked. • The Pandora® version is not supported. Update to the latest version.
When not driving, please see mobile device.	The Pandora® app in your smartphone is not compatible with the app launcher system.	Download the most recent version of the Pandora® app.
	The required app is not installed.	Download the HondaLink app from www.hondalink.com .
	Appears when the number of created stations reaches the limitation.	Delete the unneeded stations from the Station List.
Unable to create new station. Please try again.	Appears when you try to create a new station.	Try again later.

Error Message	Cause	Solution
Unable to play PANDORA. Please try again later.	Appears when you try to play PANDORA.	Try again later.
Unable to play PANDORA. Music licensing restricts play in this area.		Try again later.
Unable to play PANDORA. When stopped, log-in to PANDORA.		Log in to the PANDORA sever.
This PANDORA station is currently not available. Please select another station.	Appears when the station you selected is not currently available.	Select another station.

Aha™ Radio

If an error occurs while playing Aha™ Radio, you may see the following error messages.

If you cannot clear the error message, contact a dealer.

Error Message	Cause
Cannot connect to AcuraLink. When stopped, check your mobile device.	Appears when the Aha™ app is not activated. Check your device.
Incompatible USB Device Please Check Owner's Manual	Appears when an incompatible device is connected. Disconnect the device. Then turn the audio system off, and turn it on again. Do not reconnect the device that caused the error.

Reference Information

System Initialization	300	Map Coverage	305
Entering the Security Code	300	Obtaining a Navigation Update	306
Acquiring GPS Information	300	Traffic Information	306
Startup Confirmation Screen	301	Operation in Alaska, Hawaii, Canada, Puerto Rico, and Mexico	306
Map Matching	301	Legal Information	307
System Limitations	302	Copyrights	307
GPS System	302	User Agreements	307
Address Calculation	302	As required by the FCC	312
Database	302		
Client Assistance	304		
Resolving Problems	304		
Reporting Errors	304		
Acura Client Relations Contact Information	304		
Visiting a Dealer	305		

The navigation system must be initialized if power to the navigation system is interrupted for any reason (e.g., the battery was disconnected).

Entering the Security Code

In most cases, you do not need to enter a security code. Follow the steps to reactivate the system.

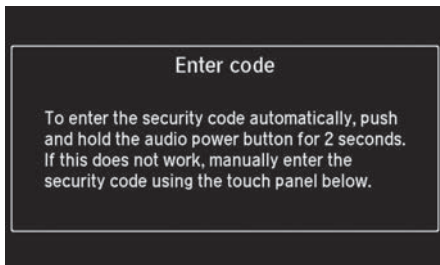

1. Set the power mode to ON, and turn on the audio system.
2. Press and hold the  (Power) button for more than two seconds.
 - ▶ The system is reactivated when the system's control unit recognizes that the system is in your vehicle. If the control unit fails to recognize, you must go to a dealer and have the system checked.

Acquiring GPS Information

Depending on the length of time the power was interrupted, your system may require GPS initialization.

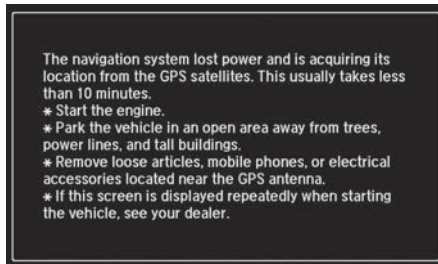

If initialization is not necessary, the system proceeds directly to the Startup Confirmation screen.
If the system fails to locate a sufficient number of satellites to locate your position within 10 minutes, the following screen is displayed.

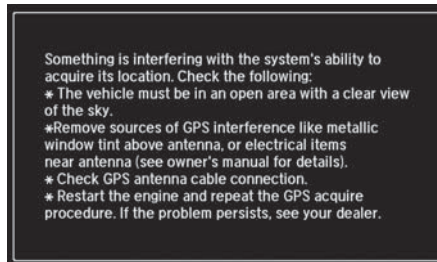

If you are experiencing GPS reception problems:

➤ **GPS System P. 302**

Startup Confirmation Screen

The Startup Confirmation screen is displayed when initialization has successfully completed. It is displayed every time you start your vehicle. Press  to select **OK** to continue.

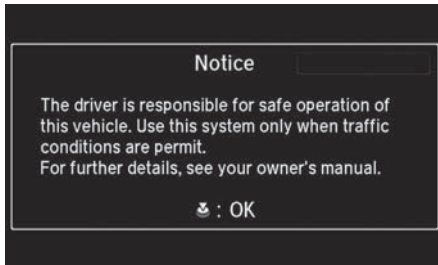

Map Matching

Map matching is the process of using the acquired GPS information to locate your position on the map screen. If you are on a mapped road, the name of the road is displayed along the bottom of the map screen when map matching is completed. Do not enter a destination until the road name is displayed.

The system may initially show your location on a different street (e.g., in urban areas where streets are close together), may show an incorrect elevation, or may delay the display of the vehicle position icon at intersections. This is normal; the system will correct itself while you drive.

GPS System

The signals received from the GPS satellites are extremely weak (less than a millionth of the strength of a local FM station) and require an unobstructed view of the sky. The GPS antenna is located in the dashboard. The signal reception can easily be interrupted or interfered with by the following:

- Metallic window tint on the front or side windows
- Mobile phones, PDAs, or other electronic devices docked in a cradle or lying loose on the dashboard
- Remote starters or “hidden” vehicle tracking systems mounted near the navigation unit
- Audio electronic devices mounted near the navigation unit
- Trees, tall buildings, freeway/highway overpasses, tunnels, or overhead electrical power wires

The GPS is operated by the U.S. Department of Defense. For security reasons, there are certain inaccuracies built into the GPS for which the navigation system must constantly compensate. This can cause

occasional positioning errors of up to several hundred feet or tens of meters.

Address Calculation

The destination icon shows only the approximate location of a destination address. This occurs if the number of possible addresses is different from the number of actual addresses on a block. For example, the address 1425 on a 1400 block with 100 possible addresses (because it is followed by the 1500 block) will be shown a quarter of the way down the block by the system. If there are only 25 actual addresses on the block, the actual location of address 1425 would be at the end of the block.

Database

The digitized map database reflects conditions as they existed at various points in time before production. Accordingly, your database may contain inaccurate or incomplete data or information due to the passage of time, road construction, changing conditions, or other causes. For example, some places/landmarks may be missing when you search the database because the name was misspelled, the place was improperly categorized, or a place/landmark is not yet in the database. This is also true for police stations, hospitals, and other public institutions. Do not rely on the navigation system if you need law enforcement or hospital services. Always check with local information sources. In addition, the map database contains verified and unverified areas. Unverified streets may be missing from the map, in the wrong location, or have an incorrect name or address range. A message will warn you if your route includes unverified streets. Exercise additional caution when driving in unverified areas.

The database does not include, analyze, process, consider, or reflect any of the following categories of information:

- Neighborhood quality or safety
- Population density
- Availability or proximity of law enforcement
- Emergency, rescue, medical, or other assistance
- Construction work, zones, or hazards
- Road and lane closures
- Legal restrictions (such as vehicular type, weight, load, height, and speed restrictions)
- Road slope or grade
- Bridge height, width, weight, or other limits
- Traffic facilities safety
- Special events
- Pavement characteristics or conditions

Every effort has been made to verify that the database is accurate. The number of inaccuracies you experience increases the longer you go without obtaining an updated map database.

📄 Obtaining a Navigation Update P. 306

We assume no liability for any incident that may result from an error in the program, or from changed conditions not noted above.

Resolving Problems

If you run into a specific issue that you cannot resolve, consult the following help resources:

- For navigation system issues:
 - **Troubleshooting** P. 284
- There are also FAQs available online at www.acuranavi.com (U.S.) or www.acuranavi.ca (Canada).
- For traffic-related issues:
 - **Traffic** P. 286
- For reporting issues with the database or places/landmarks:
 - **Reporting Errors** P. 304
- Call Acura Client Relations.
 - **Acura Client Relations Contact Information** P. 304

Reporting Errors

You can help to improve database accuracy by reporting any errors you encounter.

- Report errors in freeways/highways and main “verified” roads shown in black on the map at <http://mapreporter.navteq.com/dur-web-external/>.
- Please do not report errors in purple “unverified” roads. Maps for these areas are provided for reference only.
 - **Unverified Routing** P. 56
- Please do not report errors in places/landmarks, such as changes in business names. Information about points of interest are constantly being updated. An updated database is available for purchase, usually in the fall of each year.
 - **Obtaining a Navigation Update** P. 306
- For vehicle position icon errors, screen error messages, or other GPS-related errors:
 - **Troubleshooting** P. 284
 - **System Limitations** P. 302

Acura Client Relations Contact Information

Acura Navi
American Honda Motor Co., Inc.
Acura Client Relations
Mail Stop 500-2N-7E
1919 Torrance Blvd.
Torrance, CA 90501-2746
Telephone: (800) 382-2238

Honda Canada Inc.
Acura Client Relations
180 Honda Boulevard
Markham, L6C 0H9, ON
E-Mail: acura_cr@ch.honda.com
Telephone: (888) 9-ACURA-9
Hours: 8:00 am to 7:30 pm
Monday to Friday (Eastern time)

Visiting a Dealer

If you have a question that you cannot resolve using the available help resources, you can consult a dealer. Please identify the specific issue (e.g., error occurs when you enter a specific address, when driving on a certain road, or just when it's cold) so that the service technician can refer the issue to the factory so that a solution can be found. Be patient, the service technician may be unfamiliar with your specific issue.

Map Coverage

The navigation system provides map coverage for the United States, Canada, Puerto Rico, and Mexico. The map coverage consists of accurately mapped (verified) metropolitan areas and a less accurate (unverified) rural database. Note that unverified areas are constantly being reviewed and converted to verified areas each year.



Map coverage update information is available from Acura Client Relations or online at www.acuranavi.com (U.S.) or www.acuranavi.ca (Canada).

To find navigation system update information:

1. Visit the website.
2. Enter your vehicle model and model year.
3. Click Map Coverage to display a list of verified coverage areas on the most recent update.
4. Click Map Coverage Details to display a PDF document with a full listing of all coverage areas.
 - ▶ Adobe® Reader® is required for viewing and printing the Portable Document Format (PDF) documents. To download the latest version of Adobe Reader, visit <http://get.adobe.com/reader/>.

Obtaining a Navigation Update

Acura is continually expanding the scope of the navigation system. Navigation system software upgrades may be made available periodically, usually in the fall of each year. To purchase an update:

1. Obtain your vehicle's VIN number and the System/Device Information.
 - 📄 **System Device Information** P. 280
2. Call the Acura Navigation Disc Fulfillment Center at (888) 549-3798, or order online at www.acuranavi.com (U.S.) or www.acuranavi.ca (Canada).

An update is not available from a dealer. However, the dealer may assist you in obtaining one for you out of courtesy. There is no program for free updates.

Traffic Information

Continuously updated traffic information is available in major metropolitan areas across the 48 contiguous states and some cities in Canada. A list of coverage areas is available online.

To find traffic information:

1. Visit www.acura.com/realtimetraffic.
2. Select Real-Time Traffic on the TLX.
3. Click AcuraLink Real-Time Traffic.

Operation in Alaska, Hawaii, Canada, Puerto Rico, and Mexico

Map Coverage

All roads displayed on the map screens are verified roads. Information in this manual relating to "unverified" roads or areas is not applicable.

Address and Place Entry Screens

Entering a destination address or place/landmark on another island may result in a screen caution message. This is because there are no ferry routes between islands in the database.

Puerto Rico and Mexico

If **Street Name Guidance** is set to **On**, the street names will not be read out by voice guidance. This may change in a future data update.

Copyrights

- Infogroup-Data: Certain business data provided by Infogroup © 2011, All Rights Reserved.
- EXIT-Data: © ZENRIN CO., LTD. 2011. All rights reserved.
- Building foot print: © ZENRIN CO., LTD. 2011. All rights reserved.
- Junction View Data: © ZENRIN USA, INC. 2011. All rights reserved.
- Brand icon: The marks of companies displayed by this product to indicate business locations are the marks of their respective owners. The use of such marks in this product does not imply any sponsorship, approval, or endorsement by such companies of this product.

User Agreements

Navigation System User Agreement

In using this HDD "Satellite Linked Navigation System" (the "HDD"), which includes HONDA MOTOR CO., LTD. software, ALPINE ELECTRONICS, INC. software, and NAVTEQ database contents (hereinafter referred to as "Licensors"), you are bound by the terms and conditions set forth below. By using your copy of the HDD, you have expressed your Agreement to the terms and conditions of this Agreement. You should, therefore, make sure that you read and understand the following provisions. If for any reason you do not wish to be bound by the terms of this Agreement, please return the HDD to your dealer.

- The HDD may not be copied, duplicated, or otherwise modified, in whole or in part, without the express written permission of the Licensors.
- The HDD may not be transferred or sublicensed to any third party for profit, rent or loan, or licensed for reuse in any manner.

- The HDD may not be decompiled, reverse engineered or otherwise disassembled, in whole or in part.
- The HDD may not be used in a network or by any other manner of simultaneous use in multiple systems.
- The HDD is intended solely for personal use (or internal use where the end-user is a business) by the consumer. The HDD is not to be used for commercial purposes.
- The Licensors do not guarantee to the client that the functions included in the HDD meet the specific objectives of the user.
- Licensor shall not be responsible for any damages caused by the use of the HDD to the actual user or to any third party.
- The warranty on the HDD shall not extend to an exchange or refund due to misspelling, omission of letters, or any other cosmetic discrepancy in the contents of the HDD.
- The right to use the HDD shall expire either when the user destroys the HDD or software, or when any of the terms of this Agreement are violated and the Licensors exercise the option to revoke the license to use the HDD or software.

- The terms and conditions hereof apply to all subsequent users and owners as well as to the original purchaser.
- The logos of oil companies, hotels, convenience stores, and other businesses are displayed for your information and convenience, and in no way imply any sponsorship, approval or endorsement of these companies, or their products. The logos are trademarks of their respective owners.
- The marks of companies displayed by this product to indicate business locations are the marks of their respective owners.
- The use of such marks in this product does not imply any sponsorship, approval, or endorsement by such companies of this product.

The user shall indemnify and save harmless the Licensors, and their officers, employees and agents, from and against any claim, demand or action, irrespective of the nature of the cause of the claim, demand or action, alleging loss, costs, expense, damages or injuries (including injuries resulting in death) arising out of the use or possession of the HDD or software.

Use, duplication, or disclosure of this HDD by or on behalf of the United States

government is subject to “Restricted Rights” as set forth at FAR 52.227-14, -19 or DFARS 252.227-7013, as applicable. Manufacturers are the Licensors, including HONDA MOTOR CO., LTD., 2-1-1 Minami Aoyama Minato-Ku Tokyo 107-8556 JAPAN., Alpine Electronics, Inc., 20-1 Yoshima Kogyodanchi, Iwaki, Fukushima 970-1192 JAPAN., NAVTEQ Corporation, 425 W Randolph St. Chicago, IL 60606, USA.

Navigation System END USER LICENSE AGREEMENT

You have acquired a device (“DEVICE”) that includes software licensed by Alpine Electronics, Inc. (collectively “ALPINE”) from an affiliate of Microsoft Corporation (collectively “MS”). Those installed software products of MS origin, as well as associated media, printed materials, and “online” or electronic documentation (“SOFTWARE”) are protected by international intellectual property laws and treaties. The SOFTWARE is licensed, not sold. All rights reserved. IF YOU DO NOT AGREE TO THIS END USER LICENSE AGREEMENT (“EULA”), DO NOT USE THE DEVICE OR COPY THE SOFTWARE

INSTEAD, PROMPTLY CONTACT ALPINE FOR INSTRUCTIONS ON RETURN OF THE UNUSED DEVICE(S) FOR A REFUND. ANY USE OF THE SOFTWARE, INCLUDING BUT NOT LIMITED TO USE ON THE DEVICE, WILL CONSTITUTE YOUR AGREEMENT TO THIS EULA (OR RATIFICATION OF ANY PREVIOUS CONSENT).

- GRANT OF SOFTWARE LICENSE
This EULA grants you the following license: You may use the SOFTWARE only on the DEVICE.
- NOT FAULT TOLERANT
THE SOFTWARE IS NOT FAULT TOLERANT. ALPINE HAS INDEPENDENTLY DETERMINED HOW TO USE THE SOFTWARE IN THE DEVICE, AND MS HAS RELIED UPON ALPINE TO CONDUCT SUFFICIENT TESTING TO DETERMINE THAT THE SOFTWARE IS SUITABLE FOR SUCH USE.
- NO WARRANTIES FOR THE SOFTWARE
THE SOFTWARE is provided “AS IS” and with all faults. THE ENTIRE RISK AS TO SATISFACTORY QUALITY, PERFORMANCE, ACCURACY, AND EFFORT (INCLUDING LACK OF NEGLIGENCE) IS WITH YOU. ALSO, THERE IS NO WARRANTY AGAINST

INTERFERENCE WITH YOUR ENJOYMENT OF THE SOFTWARE OR AGAINST INFRINGEMENT. IF YOU HAVE RECEIVED ANY WARRANTIES REGARDING THE DEVICE OR SOFTWARE THOSE WARRANTIES DO NOT ORIGINATE FROM, AND ARE NOT BINDING ON, MS.

- NO LIABILITY FOR CERTAIN DAMAGES. EXCEPT AS PROHIBITED BY LAW, MS, MICROSOFT CORPORATION AND THEIR AFFILIATES SHALL HAVE NO LIABILITY FOR ANY INDIRECT, SPECIAL, CONSEQUENTIAL OR INCIDENTAL DAMAGES ARISING FROM OR IN CONNECTION WITH THE USE OR PERFORMANCE OF THE SOFTWARE. THIS LIMITATION SHALL APPLY EVEN IF ANY REMEDY FAILS OF ITS ESSENTIAL PURPOSE. IN NO EVENT SHALL MS, MICROSOFT CORPORATION AND/OR THEIR AFFILIATES BE LIABLE FOR ANY AMOUNT IN EXCESS OF U.S. TWO HUNDRED FIFTY DOLLARS (U.S.\$250.00).
- SPEECH RECOGNITION
If the SOFTWARE includes speech recognition component(s), you should understand that speech recognition is an inherently statistical process and that recognition errors are inherent in the

process. Neither ALPINE nor its suppliers shall be liable for any damages arising out of errors in the speech recognition process.

- LIMITATIONS ON REVERSE ENGINEERING, DECOMPIATION, AND DISASSEMBLY
You may not reverse engineer, decompile, or disassemble the SOFTWARE, except and only to the extent that such activity is expressly permitted by applicable law notwithstanding this limitation.
- ADDITIONAL SOFTWARE/SERVICES
The SOFTWARE may permit ALPINE, MS, Microsoft Corporation or their affiliates to provide or make available to you SOFTWARE updates, supplements, add-on components, or Internet-base service components of the SOFTWARE after the date you obtain your initial copy of the SOFTWARE ("Supplemental Components").
 - ▶ If ALPINE provides or makes available to you Supplemental Components and no other EULA terms are provided along with the Supplemental Components, then the terms of this EULA shall apply.

- ▶ If MS, Microsoft Corporation or their affiliates make available Supplemental Components, and no other EULA terms are provided, then the terms of this EULA shall apply, except that MS, Microsoft Corporation or affiliate entity providing the Supplemental Component(s) shall be licensor of the Supplemental Component(s).
- ▶ ALPINE, MS, Microsoft Corporation and their affiliates reserve the right to discontinue any Internet-based services provided to you or made available to you through the use of the SOFTWARE.
- RECOVERY MEDIA
If SOFTWARE is provided by ALPINE on separate media and labeled "Recovery Media" you may use the Recovery Media solely to restore or reinstall the SOFTWARE originally installed on the DEVICE.
- UPGRADES
If the SOFTWARE is provided by ALPINE separate from the DEVICE on separate media or via web download or other means, and is labeled "For Upgrade Purposes Only" you may install one (1) copy of such SOFTWARE onto the

DEVICE as a replacement copy for the existing SOFTWARE, and use it in accordance with this EULA, including any additional EULA terms accompanying the upgrade SOFTWARE.

- **TERMINATION**

Without prejudice to any other rights, ALPINE or MS may terminate this EULA if you fail to comply with the terms and conditions of this EULA. In such event, you must destroy all copies of the SOFTWARE and all of its component parts.

- **INTELLECTUAL PROPERTY RIGHTS**

All title and intellectual property rights in and to the SOFTWARE (including but not limited to any images, photographs, animations, video, audio, music, text and “applets,” incorporated into the SOFTWARE), the accompanying printed materials, and any copies of the SOFTWARE, are owned by MS, Microsoft Corporation, their affiliates or suppliers. The SOFTWARE is licensed, not sold. You may not copy the printed materials accompanying the SOFTWARE. All title and intellectual property rights in and to the content which may be accessed through use of the SOFTWARE is the

property of the respective content owner and may be protected by applicable copyright or other intellectual property laws and treaties. This EULA grants you no rights to use such content. All rights not specifically granted under this EULA are reserved by MS, Microsoft Corporation, their affiliates and suppliers. Use of any on-line services which may be accessed through the SOFTWARE may be governed by the respective terms of use relating to such services. If this SOFTWARE contains documentation that is provided only in electronic form, you may print one copy of such electronic documentation.

- **TRADEMARKS**

This EULA does not grant you any rights in connection with any trademarks or service marks of ALPINE MS, Microsoft Corporation, their affiliates or suppliers.

- **PRODUCT SUPPORT**

Product support for the SOFTWARE is not provided by MS, its parent corporation Microsoft Corporation, or their affiliates or subsidiaries. For product support, please refer to ALPINE support number

provided in the documentation for the DEVICE.

Should you have any questions concerning this EULA, or if you desire to contact ALPINE for any other reason, please refer to the address provided in the documentation for the DEVICE.

- **SOFTWARE TRANSFER ALLOWED BUT WITH RESTRICTIONS**

You may permanently transfer rights under this EULA only as part of a permanent sale or transfer of the Device, and only if the recipient agrees to this EULA. If the SOFTWARE is an upgrade, any transfer must also include all prior versions of the SOFTWARE.

- **EXPORT RESTRICTIONS**

You acknowledge that SOFTWARE is of US-origin. You agree to comply with all applicable international and national laws that apply to the SOFTWARE, including the U.S. Export Administration Regulations, as well as end-user, end-use and country destination restrictions issued by U.S. and other governments. For additional information on exporting the SOFTWARE, see <http://www.microsoft.com/exporting/>.

■ Gracenote Music Recognition Service (CDDB)



Music recognition technology and related data are provided by Gracenote®. Gracenote is the industry standard in music recognition technology and related content delivery.

For more information, visit www.gracenote.com.

When music is recorded to the HDD from a CD, information such as the recording artist and track name are retrieved from the Gracenote Database and displayed (when available).

Gracenote may not contain information for all albums.

Gracenote is an internet-based music recognition service that allows artist, album, and track information from CDs to display on the HDD.

Gracenote users are allowed 4 free updates a year. More information about Gracenote, its features, and downloads are available at www.honda.com (in U.S.) or www.honda.ca (in Canada).

CD and music-related data from Gracenote, Inc., copyright © 2000 to present Gracenote. Gracenote Software, copyright © 2000 to present Gracenote. One or more patents owned by Gracenote apply to this product and service. See the Gracenote website for a non-exhaustive list of applicable Gracenote patents. Gracenote, CDDB, MusicID, MediaVOCS, the Gracenote logo and logotype, and the “Powered by Gracenote” logo are either registered trademarks or trademarks of Gracenote in the United States and/or other countries.

■ Gracenote® END USER LICENSE AGREEMENT

This application or device contains software from Gracenote, Inc. of Emeryville, California (“Gracenote”). The software from Gracenote (the “Gracenote Software”) enables this application to perform disc and/or file identification and obtain music-related information, including name, artist, track, and title information (“Gracenote Data”) from online servers or embedded databases (collectively, “Gracenote Servers”) and to perform other

functions. You may use Gracenote Data only by means of the intended End-User functions or this application or device. You agree that you will use Gracenote Data, the Gracenote Software, and Gracenote Servers for your own personal non-commercial use only.

You agree not to assign, copy, transfer, or transmit the Gracenote Software or any Gracenote Data to any third party. YOU AGREE NOT TO USE OR EXPLOIT GRACENOTE DATA, THE GRACENOTE SOFTWARE, OR GRACENOTE SERVERS, EXCEPT AS EXPRESSLY PERMITTED HEREIN. You agree that your non-exclusive license to use the Gracenote Data, the Gracenote Software, and Gracenote Servers will terminate if you violate these restrictions. If your license terminates, you agree to cease any and all use of the Gracenote Data, the Gracenote Software, and Gracenote Servers.

Gracenote reserves all rights in Gracenote Data, the Gracenote Software, and the Gracenote Servers, including all ownership rights. Under no circumstances will Gracenote become liable for any payment to you for any information that you provide. You agree that Gracenote, Inc. may enforce

its rights under this Agreement against you directly in its own name.

The Gracenote service uses a unique identifier to track queries for statistical purposes. The purpose of a randomly assigned numeric identifier is to allow the Gracenote service to count queries without knowing anything about who you are. For more information, see the web page for the Gracenote Privacy Policy for the Gracenote service.

The Gracenote Software and each item of Gracenote Data are licensed to you "AS IS." Gracenote makes no representations or warranties, express or implied, regarding the accuracy of any Gracenote Data from in the Gracenote Servers. Gracenote reserves the right to delete data from the Gracenote Servers or to change data categories for any cause that Gracenote deems sufficient. No warranty is made that the Gracenote Software or Gracenote Servers are error-free or that functioning of Gracenote Software or Gracenote Servers will be uninterrupted.

Gracenote is not obligated to provide you with new enhanced or additional data types or categories that Gracenote may provide in

the future and is free to discontinue its services at any time.

GRACENOTE DISCLAIMS ALL WARRANTIES EXPRESS OR IMPLIED, INCLUDING, BUT NOT LIMITED TO, IMPLIED WARRANTIES OF MERCHANTABILITY, FITNESS FOR A PARTICULAR PURPOSE, TITLE, AND NONINFRINGEMENT. GRACENOTE DOES NOT WARRANT THE RESULTS THAT WILL BE OBTAINED BY YOUR USE OF THE GRACENOTE SOFTWARE OR ANY GRACENOTE SERVER. IN NO CASE WILL GRACENOTE BE LIABLE FOR ANY CONSEQUENTIAL OR INCIDENTAL DAMAGES OR FOR ANY LOST PROFITS OR LOST REVENUES.

copyright © 2000 to present Gracenote

As required by the FCC

1. This device complies with Part 15 of the FCC Rules and Canadian RSS-210/RSSGen. Operation is subject to the following two conditions: (1) this device may not cause harmful interference, and (2) this device must accept any interference received, including interference that may cause undesired operation.
2. The FCC requires the user to be notified that any changes or modifications made to this device that are not expressly approved by the party responsible for compliance may void the user's authority to operate the equipment.
3. This product emits radio frequency energy, but the radiated output power of this device is far below the FCC and IC radio frequency exposure limits. This equipment complies with FCC and IC RF radiation exposure limits set forth for an uncontrolled environment. Nevertheless, the device should be used in such a manner that the potential for human contact with the antenna during normal operation is minimized.



Voice Commands

Voice Commands	314
Navigation Commands	314
Voice Portal Commands	316
Phone Commands	316
Info Commands	317
Climate Control Commands	317
Audio Commands	318
On-Screen Commands	321
Spelling Assistance	321
List of Categories	325

Navigation Commands

The system accepts these commands on a map/guidance screen.

General Commands

Display voice portal
Display phone (equivalent to **PHONE**)
Display audio (equivalent to **AUDIO**)
Display navigation (if en route, displays the Route screen)
Display information (equivalent to **INFO**)
Display menu (equivalent to **MENU**. if en route, displays Route Options)
Display setting (equivalent to **SETTINGS** button)
Display map
Display map guide (when en route, shows the next guidance point)
Display audio
Cancel
What time is it?
What is today's date?
Voice help (displays commands for current screen)
Messages

Map Display Commands

Display current location (shows current latitude, longitude, and elevation)
Display/Hide (specify icon type):
ATM
gas station
restaurant
post office
grocery store
lodging (hotel, motel)
parking garage
parking lot
school
hospital
freeway exit information (U.S.)
highway exit information (Canada)
traffic
traffic speeds
traffic icons
traffic incidents
Go home
Register the current location (stores current location in the Address Book)

Map Scale Commands

Display north up
Display heading up
Display 3D map
Display zoom in
Display zoom out
Display (specify scale):
1/20 mile (80 m) scale
1/8 mile (200 m) scale
1/4 mile (400 m) scale
1/2 mile (800 m) scale
1 mile (1600 m) scale
2 mile (3 km) scale
5 mile (8 km) scale
15 mile (24 km) scale
50 mile (80 km) scale
150 mile (240 km) scale
350 mile (560 km) scale
1000 mile (1600 km) scale
Max zoom in
Max zoom out

Find Place Commands

Find nearest (specify place):

Fuel and auto

Acura dealers

Honda dealers

Gas station

Hydrogen station

Auto parts & electronics

Auto repair & maintenance

Car wash & detailing

Motorcycle dealers

Other car dealers

Roadside assistance

ATM and bank

ATM

Bank

Check cashing

Currency exchange

Community

Business

City hall

Civic center

Convention center

Court house

Higher education

Library

Post office

School

Emergency room

Hospital

Police station

Veterinarian

Lodging

Bed & breakfast

Hotel

Resort

Recreation

Amusement park

Golf course

Historical monument

Marina

Movie theater

Museum

Park

Performing arts

Sports complex

Tourist attraction

Restaurant

American restaurant

Californian restaurant

Chinese restaurant

Coffee shop

Continental restaurant

Fast food

French restaurant

German restaurant

Greek restaurant

Indian restaurant

Italian restaurant

Japanese restaurant

Korean restaurant

Mexican restaurant

Pizza

Seafood restaurant

Thai restaurant

Vegetarian restaurant

Vietnamese restaurant

Other restaurant

Shopping

Shopping area

Accessory store

Book store

Clothing store

Grocery store

Home improvement store

Mall

Office supply store

Pharmacy

Pet food store

Sewing store

Shoe store

Sporting goods store

Toy store

Travel center
Airport
Automobile club
Bus station
Camping
Commuter rail station
Ferry terminal
Named place
Park & ride
Parking garage
Parking lot
Rental car agency
Rest area
Ski area
Tourist information
Train station
Travel agency
Truck stop

■ Route Commands

The system accepts these commands when a route is set.

*How long to the destination?**
*How far to the destination?**
Display destination map
Display entire route
Cancel route
Repeat guidance

* These commands are not available if you scroll through the map while en route to a destination.

Voice Portal Commands

The system accepts these commands on the **Voice Portal** screen.

Call Your contact name
Call Phone Number
Address (U.S.)
Place Name (U.S.)
Find nearest POI category name (Canada)
Go home
Cancel route

Phone Commands

The system accepts these commands on any screen.

Call by number
Call by name
Call (phone number)
Call (contact name)

Contacts that are imported from your phone to the vehicle are all made available by voice. Voice Tags can also be recorded for each of your Speed Dial entries.

Info Commands

The system accepts these commands on any screen.

Trip computer
Display traffic
Display clock
Display wallpaper

Climate Control Commands

The system accepts these commands on most screens.

Climate control automatic^{*1}
Climate control off^{*1}
Air conditioner on^{*1}
Air conditioner off^{*1}
Climate control defrost on^{*1}
Climate control defrost off^{*1}
Rear defrost on^{*1}
Rear defrost off^{*1}
Climate control fresh air
Climate control recirculate
Climate control vent
Climate control bi-level
Climate control floor
Climate control floor and defrost
Climate control mode automatic

Fan speed up
Fan speed down
Fan speed # (#: 1 to 7)
Fan automatic
Temperature # degrees (#: 57 to 87°F, 15 to 29°C)
Driver temperature # degrees (#: 57 to 87°F, 15 to 29°C)
Passenger temperature # degrees (#: 57 to 87°F, 15 to 29°C)
Temperature up
Temperature down
Driver temperature up
Driver temperature down
Passenger temperature up
Passenger temperature down
Temperature max heat
Temperature max cool
Driver temperature max heat
Driver temperature max cool
Passenger temperature max heat
Passenger temperature max cool
Climate control sync on^{*1}
Climate control sync off^{*1}
Driver heated seat automatic
Passenger heated seat automatic
Driver heated seat off
Passenger heated seat off

Driver ventilated seat automatic^{*2}
Passenger ventilated seat automatic^{*2}
Driver ventilated seat off^{*2}
Passenger ventilated seat off^{*2}
Driver heated seat high
Driver heated seat medium
Driver heated seat low
Passenger heated seat high
Passenger heated seat medium
Passenger heated seat low
Driver ventilated seat high^{*2}
Driver ventilated seat low^{*2}
Passenger ventilated seat high^{*2}
Passenger ventilated seat low^{*2}

*1: These commands toggle the function on and off, so the command may not match your intended action.

*2: Not available on all models

Audio Commands

The system accepts these commands on most screens.

■ Using Song By Voice™

Song By Voice™ is a feature that allows you to select music from your Hard Disc Drive or iPod device using your voice.

To activate this mode, you must press the  (Talk) button on the **Voice Portal** screen and say: "Music search."

■ Song By Voice™ commands

Music search
What am I listening to?
Who am I listening to?
Who is this?
What's playing?
Who's playing?
What album is this?

■ HDD commands

Hard Disc Drive play
Hard Disc Drive play track # (#: 1 to 30)
Hard Disc Drive skip forward
Hard Disc Drive skip back

*Hard Disc Drive album up*2*
*Hard Disc Drive album down*2*
Hard Disc Drive track up
Hard Disc Drive track down
*Hard Disc Drive playlist up*2*
*Hard Disc Drive playlist down*2*
*Hard Disc Drive track random*1*
*Hard Disc Drive track repeat*1*
*Hard Disc Drive track scan*1*
Hard Disc Drive normal play
What am I listening to?
Who am I listening to?
Who is this?
What's playing?
Who's playing?
What album is this?

*1: These commands toggle the function on and off, so the command may not match your intended action.

*2: These commands are available only in the corresponding playback mode.

For example, "Artist" commands are available only in "Artist" mode.

■ Radio commands

*Audio on*1*
*Audio off*1*
*Radio on*1*
*Radio off*1*
Radio select FM
Radio select AM
Radio tune to # FM
 (#: frequency from 87.7 to 107.9)
Radio tune to # AM
 (#: frequency from 530 [five thirty] to 1710 [seventeen ten])
Radio seek up
Radio seek down
Radio next station
Radio preset # (#: 1 to 12)
Radio FM preset # (#: 1 to 12)
Radio AM preset # (#: 1 to 6)
*Radio scan*1*
Radio select XM
XM channel #
 (#: 0 to 255 [two fifty five])
XM channel up
XM channel down
XM category up
XM category down
XM preset # (#: 1 to 12)

*XM scan**1
XM category mode
XM channel mode

*1: These commands toggle the function on and off, so the command may not match your intended action.

NOTE:

Radio volume levels cannot be controlled using voice control.

Disc commands

Disc play
Disc play track # (#: 1 to 30)
Disc skip forward
Disc skip back
*Disc track random**1
*Disc track repeat**1
*Disc track scan**1
Disc folder up
Disc folder down
*Disc folder random**1
*Disc folder repeat**1
*Disc folder scan**1
Disc normal play

*1: These commands toggle the function on and off, so the command may not match your intended action.

iPod commands

iPod play
iPod pause
iPod play track # (#: 1 to 30)
iPod skip forward
iPod skip back
*iPod track shuffle**1
*iPod album shuffle**1
*iPod track repeat**1
iPod normal play
What am I listening to?
Who am I listening to?
Who is this?
What's playing?
Who's playing?
What album is this?

*1: These commands toggle the function on and off, so the command may not match your intended action.

■ USB commands

USB play
USB play track # (#: 1 to 30)
USB skip forward
USB skip back
*USB track random*¹*
*USB track repeat*¹*
*USB track scan*¹*
USB folder up
USB folder down
*USB folder random*¹*
*USB folder repeat*¹*
*USB folder scan*¹*
USB normal play

*1: These commands toggle the function on and off, so the command may not match your intended action.

■ Bluetooth® Audio commands

Bluetooth Audio play
Bluetooth Audio skip forward
Bluetooth Audio skip back
Bluetooth Audio group up
Bluetooth Audio group down
Bluetooth Audio pause
Bluetooth Audio resume

NOTE:

Bluetooth® Audio commands may not work on some phones or Bluetooth® Audio devices.

■ AUX commands

Auxiliary play

U.S. models

■ Pandora® commands

The system accepts these commands while the Pandora® is playing.

Pandora play
Pandora skip forward
Pandora station up
Pandora station down
Pandora pause
Pandora resume
Pandora thumbs up
Pandora thumbs down

■ Aha™ Radio commands

The system accepts these commands while the Aha™ is playing.

Aha radio play
Aha radio skip forward
Aha radio skip back
Aha radio station up
Aha radio station down
Aha radio resume
Aha radio pause
Aha radio like
Aha radio dislike

Internet service commands

Internet service play
*Internet service skip forward**¹
*Internet service skip back**¹
*Internet service station up**¹
*Internet service station down**¹
*Internet service resume**¹
*Internet service pause**¹
*Internet service like**¹
*Internet service dislike**¹

*1: The system accepts these commands while the Internet service is playing.

On-Screen Commands

The system accepts these commands on any screen. There are over 100 on-screen commands. Say what is written on the screen to activate that selection. For lists, you can say the list item number to select that item.

Next (or Down)

Previous (or Up)

Return

OK (excluding Startup Confirmation screen)

Delete

Spelling Assistance

The voice control system can also recognize phonetic alphabet input for numbers, letters, accented letters, punctuation marks, and symbols.

NOTE:

When selecting letters using the voice control system, a confirmation box may pop up to confirm the entry.

Numbers



Say ...	Say ... or Number ...
1	One
2	Two
3	Three
4	Four
5	Five
6	Six
7	Seven
8	Eight
9	Nine
0	Zero

Letters



Say ...	Or say...
A	Apple/Alpha
B	Boy/Bravo
C	Charlie
D	Dog/Delta
E	Edward/Echo
F	Frank/Foxtrot
G	George/Golf
H	Henry/Hotel
I	Igloo/India
J	John/Juliet
K	King/Kilo
L	Larry/Lima
M	Mary/Mike

Say ...	Or say...
N	Nancy/November
O	Oscar
P	Paul/Papa
Q	Queen/Quebec
R	Robert/Romeo
S	Sam/Sierra
T	Tom/Tango
U	Uncle/Uniform
V	Victor
W	William/Whiskey
X	X-ray
Y	Yellow/Yankee
Z	Zebra/Zulu

Accented Letters



Say ...	Say ... or Symbol ...
Á	<i>A acute</i>
À	<i>A grave</i>
Â	<i>A circumflex</i>
Ã	<i>A umlaut</i>
Ç	<i>C cedilla</i>
È	<i>E grave</i>
É	<i>E acute</i>
Ê	<i>E circumflex</i>
Ë	<i>E umlaut</i>
Í	<i>I acute</i>
Î	<i>I circumflex</i>
Ï	<i>I umlaut</i>
Ó	<i>O acute</i>

Say ...	Say ... or Symbol ...
Ô	<i>O circumflex</i>
Ö	<i>O umlaut</i>
Ù	<i>U grave</i>
Ú	<i>U acute</i>
Û	<i>U circumflex</i>
Ü	<i>U umlaut</i>

Symbols







Say ...	Say ... or Symbol ...
?	<i>Question mark</i>
!	<i>Exclamation point</i>
\$	<i>Dollar</i>
#	<i>Pound</i>
*	<i>Asterisk</i>
+	<i>Plus</i>
-	<i>Hyphen</i>
:	<i>Colon</i>
;	<i>Semicolon</i>
/	<i>Slash</i>
@	<i>At sign</i>
&	<i>Ampersand</i>
~	<i>Tilde</i>

Say ...	Say ... or Symbol ...
.	<i>Dot</i>
"	<i>Double quote</i>
,	<i>Comma</i>
'	<i>Apostrophe</i>
!	<i>Inverted exclamation point</i>
?	<i>Inverted question mark</i>
«	<i>Left-pointing double angle quotation mark</i>
»	<i>Right-pointing double angle quotation mark</i>
%	<i>Percent</i>
_	<i>Underscore</i>
<	<i>Less than</i>
>	<i>Greater than</i>
{	<i>Open brace</i>
}	<i>Close brace</i>
^	<i>Caret</i>
`	<i>Back quote</i>

List of Categories

Fuel/Auto		Lodging		Shopping	
All Types	Auto Repair & Maintenance	All Types	Hotel/Motel	All Types	Mall/Department Store
Acura Dealers	Car Wash & Detailing	Bed & Breakfast	Resort	Accessories/Jewelry	Office Supplies/ Electronics
Honda Dealers	Motorcycle Dealers	Recreation		Auto Parts & Electronics	Pharmacy/Drug Store
Gas Station	Other Car Dealers	All Types	Museum	Books/Music/Video	Pet Food/Supplies
Hydrogen Station	Roadside Assistance	Amusement Park	Park/Recreation Area	Clothing	Sewing/Linen
Auto Parts & Electronics		Golf Course	Performing Arts	Shoes/Bags	Sporting Goods
ATM/Bank		Historical Monument	Sports Complex	Groceries	Toys/Arts/Crafts
All Types	Check Cashing/Money Transfer	Marina	Tourist Attraction	Home Improvement	
ATM Bank	Currency Exchange	Movie Theater		Travel	
Community		Restaurant		All Types	Parking Garage/ House
All Types	Court House	All Types	Italian	Airport	Parking Lot
Business	Higher Education	American	Japanese	Automobile Club	Rental Car Agency
City Hall	Library	Café/Coffee shop	Korean	Bed & Breakfast	Resort
Civic/Community Center	Post Office	Californian	Mexican	Bus Station	Rest Area
Convention/Exhibition Center	School	Chinese	Pizza	Camping	Ski Area
Emergency		Continental	Seafood	Commuter Rail Station	Tourist Attraction
All Types	Roadside Assistance	Fast Food	Thai	Ferry Terminal	Tourist Information
Hospital	Veterinarian	French	Vegetarian	Hotel/Motel	Train Station
Police Station		German	Vietnamese	Named Place	Travel Agency
		Greek	Other	Park & Ride	Truck Stop/Plaza
		Indian			

Symbols

 (Display Mode) Button	74
 (Hang-Up/Back) Button	6, 22, 218
 (Pick-up) Button	218
 (Talk) Button	6, 22, 218

Numbers

3D Angle Adjustment	77
---------------------------	----

A

Acura Client Relations	304
AcuraLink Message	271
AcuraLink Subscription Status	275
AcuraLink®	266
Address	92
Address Book	39
Avoided Area	60
Address Book	
Editing Address Book	39
Setting Destination	99
Address Book PIN	47
Aha™ Radio	297
Aha™ Radio Menu	205
Audio	
On Demand Multi-Use Display™	5
Remote Control	153
Settings	155
Voice Commands List	318
Audio Menu	
Bluetooth® Audio	213

Disc	171
FM/AM Radio	158
HDD	178
Internet Radio	202
iPod	190
SiriusXM® Radio	164
USB Flash drive	207

Audio System

Theft Protection	150
USB Port	149

AUX

AUX commands	320
Auxiliary Input Jack	150

Avoid Streets	141
---------------------	-----

Avoided Area	60
--------------------	----

B

Black Level	26
-------------------	----

Bluetooth® Audio

Playing	213
Voice Commands List	320

Bluetooth® HandsFreeLink®

Importing Phonebook Data	227
Making a Call	244
Pairing a Phone	221
Phone Settings	239
Receiving a Call	250
Setting Up Speed Dialing	228

Brightness	26
------------------	----

C

Calculating the Route	115
-----------------------------	-----

Calendar	279
----------------	-----

Call History	248
--------------------	-----

Cancel Route	134
--------------------	-----

Category

Address Book	39
Place Category List	325
Setting Destination	101

Category History	49
------------------------	----

Change Province	93
-----------------------	----

Change State	93
--------------------	----

Changing Your Destination	142
---------------------------------	-----

Changing Your Route	133
---------------------------	-----

City	95
------------	----

Client Assistance	304
-------------------------	-----

Clock Adjustment	28
------------------------	----

Color	73
-------------	----

Continue Trip	145
---------------------	-----

Contrast	26
----------------	----

Coordinate	114
------------------	-----

Correct Vehicle Position	86
--------------------------------	----

Current Location	79
------------------------	----

Current Position

Address Book	39
Map Input	112

D

Data Reset	87
------------------	----

- Day Mode
 - Color 73
 - Switching Display Mode..... 74
 - Delete Tracking..... 85
 - Destination List
 - Adding Waypoint 135
 - Editing..... 139
 - Detour 141
 - Dial 246
 - Directions 128
 - Disc
 - Playing..... 171
 - Voice Commands List 319
 - Display Settings..... 26
 - Display Tracking..... 84
 - Driving..... 122
 - Download POI
 - Editing Category..... 51
 - Importing Category 50
 - Setting Destination 109
 - Driving to Your Destination..... 118
- E**
- Edit Go Home..... 46
 - Edit POI Search Radius Along Route 59
 - ENTER Button..... 7
 - Entering a Destination 90
 - Error Messages..... 290
 - Aha™ Radio..... 297
 - CD Player..... 291
 - Hard Disc Drive (HDD) Audio..... 292
 - iPod/USB Flash Drive 293
 - Navigation System..... 290
 - Pandora®..... 294
 - Estimated Time..... 68
 - Exit Info..... 129
- F**
- Find Nearest Place 142
 - FM/AM Radio
 - Playing 158
 - Voice Commands List 318
 - Folder List
 - Disc..... 175
 - USB Flash Drive 212
- G**
- Go Home..... 11
 - Go Home PIN 47
 - Gracenote Info. Update 188
 - Guidance (Navi Settings)..... 62
 - Guidance Mode 63
 - Guidance Point 67
- H**
- HDD
 - Playing 178
 - Voice Commands List 318
 - Hide Traffic Flow 127
 - Home Address 11, 46
 - House Number..... 98
- I**
- Import Phonebook Data..... 227
 - Interface Dial..... 7
 - Interface Settings 26
 - Intersection 111
 - iPod
 - Connecting, Disconnecting 190
 - Playing..... 190
 - Voice Commands List..... 319
- L**
- Language Settings 34
 - Legal Information 307
 - List of Categories 325
 - Lodging (Place Category) 101
- M**
- Map (Navi Settings) 69
 - Map Data Update
 - Checking Version 280
 - Obtaining Update Data 306
 - Map Input
 - Avoided Area..... 60
 - Setting Destination 112
 - Map Legend 9, 80
 - Map Menu..... 125
 - Map Screen..... 118
 - Changing View 76
 - Icon 9, 82
 - Scale..... 81

MENU Button

- Changing Route..... 133
- Entering a Destination..... 90

Microphone..... 218

Music Search

- HDD..... 183
- How to Select a File from the Music Search List (MP3/WMA/AAC)..... 175
- iPod..... 196
- Song By Voice..... 198
- USB..... 212

N

NAV Button..... 10, 63

Navigation Menu (Destination)..... 90

Navigation Menu (Route Option)..... 133

Night Mode

- Color..... 73
- Switching Display Mode..... 74

Non-map screens..... 66

O

On Demand Multi-Use Display™

- Basic Operation..... 5
- Customizing Audio Source..... 152
- Screen Settings..... 88
- Shortcuts..... 44, 151, 231
- Sound..... 156

P

Pairing a Phone..... 221

Pandora®..... 203

Personal Information..... 38

PHONE Button..... 218

Phone Settings..... 239

Phonebook

- Importing..... 227
- Making a Call..... 245

PIN Numbers..... 47

Place Category

- Address Book..... 39
- Place Category List..... 325
- Setting Destination..... 101

Place Name

- Address Book..... 39
- Setting Destination..... 105

Place Phone Number

- Address Book..... 39
- Setting Destination..... 108

Postal Code..... 94

Previous Destinations

- Address Book..... 39
- Deleting..... 48
- Setting Destination..... 100

R

Radio

- FM/AM..... 158
- SiriusXM®..... 164

Random

- Disc..... 173
- HDD..... 181
- USB Flash Drive..... 210

Repeat

- Disc..... 173
- HDD..... 181
- iPod..... 194
- USB Flash Drive..... 210

Resuming Your Trip..... 145

Roadside Assistance..... 260

Route Preference..... 54

Routing..... 53

S

Scan

- Disc..... 173
- FM/AM Radio..... 161, 162
- HDD..... 181
- SiriusXM® Radio..... 167
- USB Flash Drive..... 210

Scenic Route..... 110

Schedule

- Calendar..... 279

Search Along..... 136

Search Around..... 136

Search by Name..... 102

Search by name

- Place Category..... 101

Search Nearby..... 142

Security PIN Code..... 300

SETTINGS Button..... 4

Show Icon on Map.....	71
Siri Eyes Free	25
SiriusXM® Radio	
Playing.....	164
Voice Commands List	318
Song By Voice™	
Searching Music	198
Setting.....	197
Voice Commands List	318
Sort by Distance to Travel	101
Sound and Beep Settings	27
Sound Setup.....	156
SOURCE Button.....	153
Speed Dial	
Making a Call	249
Registering	229
Start-up	20
Steering Wheel Controls	153
Straight Line Guide.....	78
Street	96
Street Name Guidance	65
System Device Information	280
System Initialization	300
System Limitations.....	302

T

Text/E-mail Message.....	252
Traffic Incidents	131
Traffic List.....	131
Traffic Rerouting	130
Auto Reroute.....	130

Navi Settings	58
Trip Computer	278
Troubleshooting.....	16, 284

U

Unit Settings	33
Unverified Routing.....	56
Update System Software	
Obtaining Update Data	306
USB Flash Drive	
Connecting, Disconnecting.....	207
Playing	207
Voice Commands List	320
USB Port.....	149

V

View (Navi Settings).....	76
View Routes	117
Viewing the Routes.....	117

Voice

Map Menu.....	123
Voice Commands	
Basic Operation	8
Help	15
Voice Commands List	314
Voice Control System	22

Voice Control Operation

Basic Operation	6
Voice Portal.....	6
Voice Recognition Settings.....	24

Voice Tag

Phonebook Phonetic Modification.....	234
Registering a Voice Tag to a Speed Dial Entry	229

Volume

HFL Buttons	218
Left Selector Wheel.....	154
Map Menu.....	125
Sound and Beep Settings	27
Voice Recognition Settings.....	24

W

Wallpaper Settings	30
Waypoint	
Adding	135
Editing	139

Z

Zip Code	94
----------------	----

